

# Installation, Operation, and Maintenance

## Variable Refrigerant Flow System Slim and MSP Duct Indoor Unit Series

### Models:

4TVL00\*\*B100NC (Slim)

4TVD00\*\*C100ND (MSP, HSP)

### ▲ SAFETY WARNING

Only qualified personnel should install and service the equipment. The installation, starting up, and servicing of heating, ventilating, and air-conditioning equipment can be hazardous and requires specific knowledge and training. Improperly installed, adjusted or altered equipment by an unqualified person could result in death or serious injury. When working on the equipment, observe all precautions in the literature and on the tags, stickers, and labels that are attached to the equipment.

# Introduction

Read this manual thoroughly before operating or servicing this unit.

## Warnings, Cautions, and Notices

Safety advisories appear throughout this manual as required. Your personal safety and the proper operation of this machine depend upon the strict observance of these precautions.

---

The three types of advisories are defined as follows:



Indicates a potentially hazardous situation which, if not avoided, could result in death or serious injury.



Indicates a potentially hazardous situation which, if not avoided, could result in minor or moderate injury. It could also be used to alert against unsafe practices.



Indicates a situation that could result in equipment or property-damage only accidents.

---

## Important Environmental Concerns

Scientific research has shown that certain man-made chemicals can affect the earth's naturally occurring stratospheric ozone layer when released to the atmosphere. In particular, several of the identified chemicals that may affect the ozone layer are refrigerants that contain Chlorine, Fluorine and Carbon (CFCs) and those containing Hydrogen, Chlorine, Fluorine and Carbon (HCFCs). Not all refrigerants containing these compounds have the same potential impact to the environment. Trane advocates the responsible handling of all refrigerants-including industry replacements for CFCs and HCFCs such as saturated or unsaturated HFCs and HCFCs.

## Important Responsible Refrigerant Practices

Trane believes that responsible refrigerant practices are important to the environment, our customers, and the air conditioning industry. All technicians who handle refrigerants must be certified according to local rules. For the USA, the Federal Clean Air Act (Section 608) sets forth the requirements for handling, reclaiming, recovering and recycling of certain refrigerants and the equipment that is used in these service procedures. In addition, some states or municipalities may have additional requirements that must also be adhered to for responsible management of refrigerants. Know the applicable laws and follow them.

**⚠ WARNING**

**Proper Field Wiring and Grounding Required!**  
Failure to follow code could result in death or serious injury.  
All field wiring **MUST** be performed by qualified personnel. Improperly installed and grounded field wiring poses **FIRE** and **ELECTROCUTION** hazards. To avoid these hazards, you **MUST** follow requirements for field wiring installation and grounding as described in **NEC** and your local/state/national electrical codes.

**⚠ WARNING****Personal Protective Equipment (PPE) Required!**

Failure to wear proper PPE for the job being undertaken could result in death or serious injury.

Technicians, in order to protect themselves from potential electrical, mechanical, and chemical hazards, **MUST** follow precautions in this manual and on the tags, stickers, and labels, as well as the instructions below:

- Before installing/servicing this unit, technicians **MUST** put on all PPE required for the work being undertaken (Examples; cut resistant gloves/sleeves, butyl gloves, safety glasses, hard hat/bump cap, fall protection, electrical PPE and arc flash clothing). **ALWAYS** refer to appropriate Material Safety Data Sheets (MSDS)/Safety Data Sheets (SDS) and OSHA guidelines for proper PPE.
- When working with or around hazardous chemicals, **ALWAYS** refer to the appropriate MSDS/SDS and OSHA/GHS (Global Harmonized System of Classification and Labelling of Chemicals) guidelines for information on allowable personal exposure levels, proper respiratory protection and handling instructions.
- If there is a risk of energized electrical contact, arc, or flash, technicians **MUST** put on all PPE in accordance with OSHA, NFPA 70E, or other country-specific requirements for arc flash protection, **PRIOR** to servicing the unit. **NEVER PERFORM ANY SWITCHING, DISCONNECTING, OR VOLTAGE TESTING WITHOUT PROPER ELECTRICAL PPE AND ARC FLASH CLOTHING. ENSURE ELECTRICAL METERS AND EQUIPMENT ARE PROPERLY RATED FOR INTENDED VOLTAGE.**

**⚠ WARNING****Follow EHS Policies!**

Failure to follow instructions below could result in death or serious injury.

- All Ingersoll Rand personnel must follow Ingersoll Rand Environmental, Health and Safety (EHS) policies when performing work such as hot work, electrical, fall protection, lockout/tagout, refrigerant handling, etc. All policies can be found on the [BOS site](#). Where local regulations are more stringent than these policies, those regulations supersede these policies.
- Non-Ingersoll Rand personnel should always follow local regulations.

## Copyright

This document and the information in it are the property of Trane, and may not be used or reproduced in whole or in part without written permission. Trane reserves the right to revise this publication at any time, and to make changes to its content without obligation to notify any person of such revision or change.

## Trademarks

All trademarks referenced in this document are the trademarks of their respective owners.

## Revision History

Revision	Change
G	The Digit 14 change to the unit model number represents a firmware revision which enables compatibility between the indoor unit and the second generation outdoor unit (ODU) series: model numbers 4TVH/R****D, 4TVP****C); and the second generation mode control unit (MCU) series model numbers 4MCUTV****A. Additional miscellaneous corrections were made for consistency and accuracy.

# Table of Contents

Model Number Description .....	6
Preparing for Installation .....	7
Accessories .....	7
Location Considerations .....	7
Unit Dimensions .....	8
Service Clearances .....	13
Unit Insulation for High-Humidity Applications .....	13
Installation .....	15
Mounting the Unit .....	15
Purging the Unit .....	16
Installing Refrigerant Piping .....	17
Pipe Cutting .....	17
Nitrogen Flushing While Brazing .....	18
Flared Pipe Connections .....	18
Leak Testing Pipe Connections .....	20
Installing the Drain System .....	22
Centralized Drainage .....	24
Testing the Drainage .....	24
Insulation .....	26
Insulating Refrigerant Pipes .....	26
Insulating the Drainage System .....	26
Wiring the Unit .....	27
Power Wiring .....	27
Communications Wiring .....	27
Configuration .....	29
Using the Technician Utilities Tool (TUT) .....	29
Using the VRF Wireless Remote Control .....	30
The 2-Digit Segments .....	31
Installation Option #1 .....	31
Installation Option #2 .....	33
Discharge Air Temperature .....	36
Operation .....	37
Components .....	37
Operating Tips .....	37
Internal Protections .....	37
Operating Ranges .....	38
Operating Mode for Heat Pump Systems .....	38
External Static Pressure Configuration Settings .....	38
Maintenance .....	42
Cleaning the Exterior .....	42

Cleaning the Air Filter .....	42
Periodic Maintenance Checks .....	42
Troubleshooting .....	43
Error Codes .....	44

# Model Number Description

<b>4</b>	<b>T</b>	<b>V</b>	<b>D</b>	<b>0</b>	<b>0</b>	<b>1</b>	<b>2</b>	<b>B</b>	<b>1</b>	<b>0</b>	<b>0</b>	<b>N</b>	<b>C</b>
<b>1</b>	<b>2</b>	<b>3</b>	<b>4</b>	<b>5</b>	<b>6</b>	<b>7</b>	<b>8</b>	<b>9</b>	<b>10</b>	<b>11</b>	<b>12</b>	<b>13</b>	<b>14</b>

**Digit 1 – Refrigerant**

4 = R410A

**Digit 2 – Brand name**

T = Trane

**Digit 3 – System type**

V = Variable Refrigerant Flow

**Digit 4 – Configuration type**

D = MSP duct type (low pressure)

L = Slim duct type (low pressure)

**Digit 5 – Reserved for future use**

0 = Not currently used

**Digit 6, 7, 8 – Nominal capacity (Btu/h x 1,000)**

007 = 7,500 Btu/h

009 = 9,000 Btu/h

012 = 12,000 Btu/h

015 = 15,000 Btu/h

018 = 18,000 Btu/h

024 = 24,000 Btu/h

027 = 27,000 Btu/h

030 = 30,000 Btu/h

036 = 36,000 Btu/h

048 = 48,000 Btu/h

054 = 54,000 Btu/h

**Digit 9 – Major development sequence**

A = First development sequence

B = Second development sequence

C = Third development sequence

**Digit 10 – Electric power supply characteristics**

1 = 208–230/60/1

**Digit 11 – Reserved for future use**

0 = Not currently used

**Digit 12 – Reserved for future use**

0 = Not currently used

**Digit 13 – Region of sale**

N = North America (UL or ETL)

**Digit 14 – Minor design sequence**

A = First design sequence

B = Second design sequence










C = Third design sequence

D = Fourth design sequence

# Preparing for Installation

## Accessories

In addition to product literature, the following accessories are supplied with this unit. The type and quantity may differ, depending on the model.

Template	Insulation for refrigerant pipe, in	Insulation for refrigerant pipe, out	Drain insulation	Cable tie	Drain hose insulation	Flexible hose	Flexible hose clamp	Grommet
								

## Location Considerations

When deciding on a location for the indoor unit, the following factors must be considered:

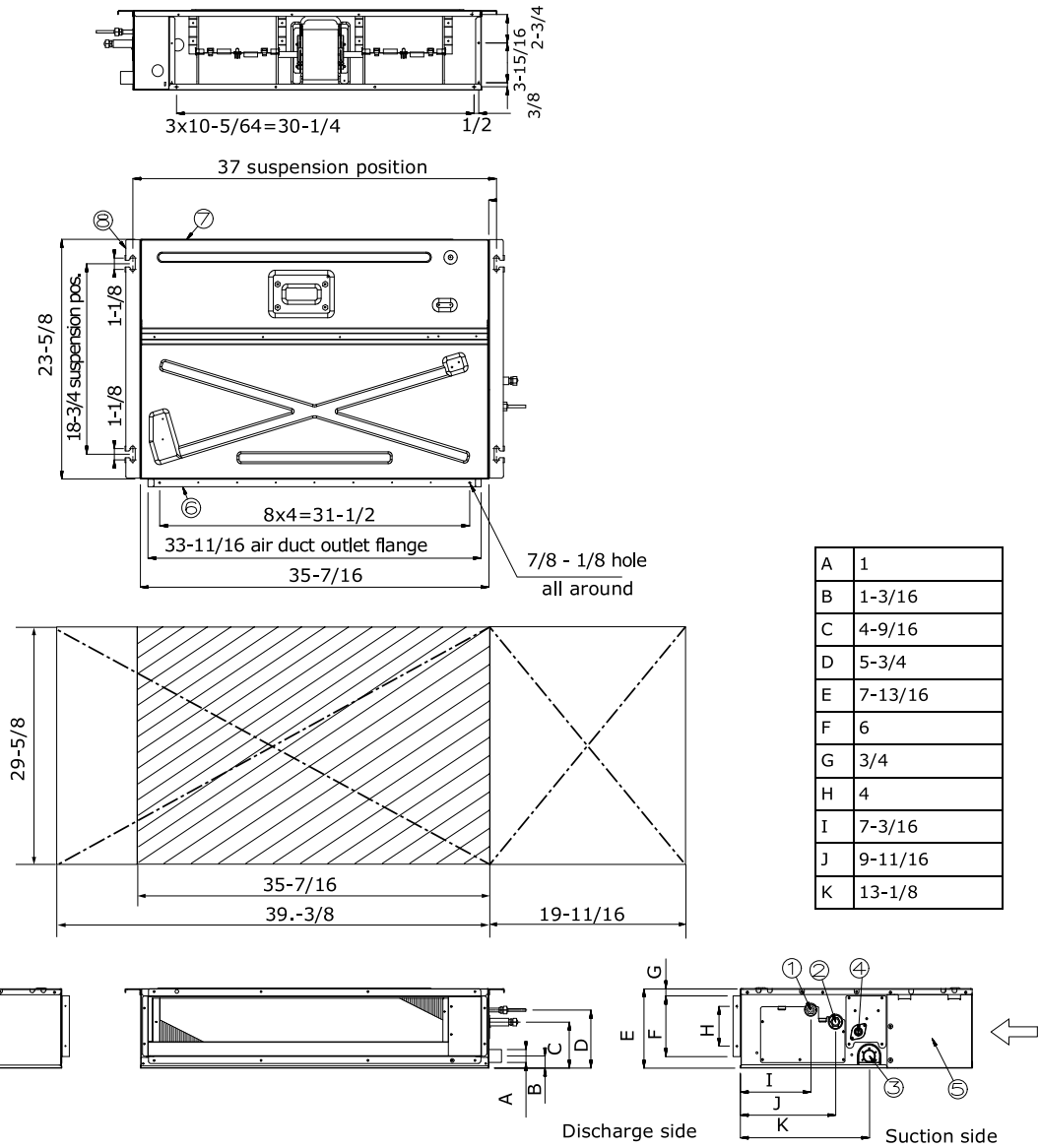
- The air inlet and outlet must be unobstructed.
- Choose a flat surface where the structure can bear the weight and vibration of the indoor unit.
- Pre-plan for easy and short routing of the refrigerant tubing and wiring to the outdoor unit.
- The air must circulate freely in the area to be cooled/heated.
- Sufficient clearance must be maintained around the unit.
- Condensate must be managed correctly and safely stored away from the unit.
- The unit should be installed in a way that prevents unauthorized access.
- The unit must not be installed in an area that is damp or could come into contact with water (such as a laundry room).
- The unit must not be exposed to direct sunshine or to other direct heat sources.
- The filter must be able to be removed and cleaned easily.
- The unit should be placed as far as possible from fluorescent lights so the remote control is not subject to interference.
- Care should be taken to prevent harmonics generated by loose or unsupported material in close proximity to a running unit.
- The unit must not be installed in an area that is exposed to salt, machine oil, sulfide gas, or corrosive environmental conditions.

# Preparing for Installation

## Unit Dimensions

4TVL0007B100N\*  
 4TVL0009B100N\*  
 4TVL0012B100N\*

Unit: inch

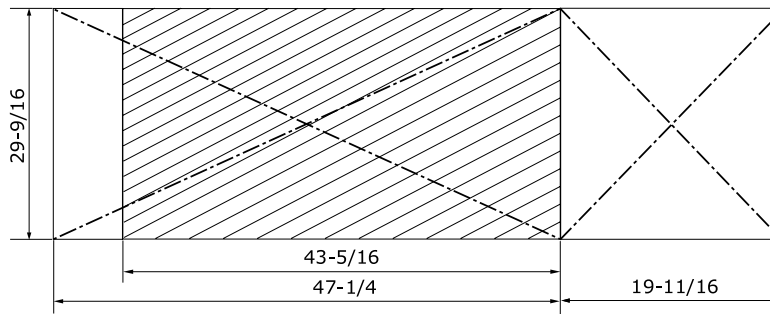
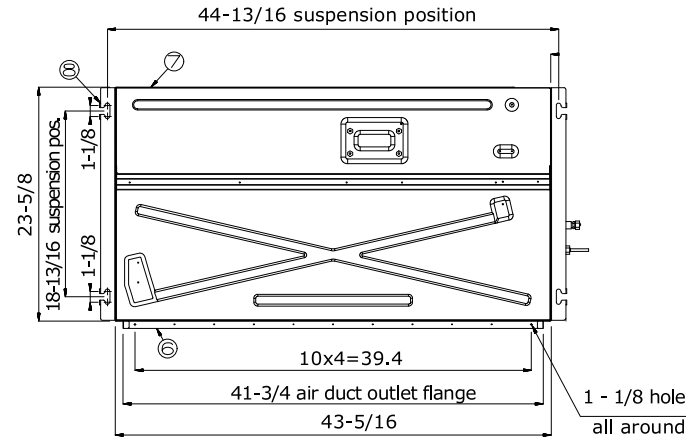
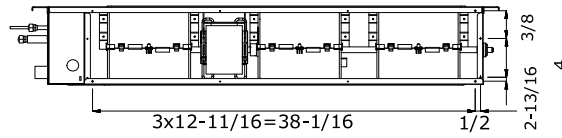


No.	Name	Description
1	Liquid pipe connection	1/4
2	Gas pipe connection	1/2
3	Drain pipe connection	OD 1, ID 0.78
4	Drain pipe connection (optional drain pump)	OD 1, ID 0.78
5	Power supply/communications connection	—
6	Air discharge grill flange	—
7	Air filter	—
8	Mounting hooks	3/8 or M10

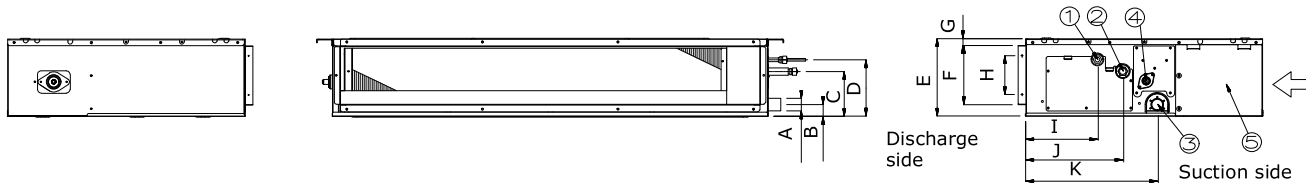


4TVL0018B100N\*  
4TVL0024B100N\*

Unit: inch



A	1
B	1-3/16
C	4-9/16
D	5-11/16
E	7-13/16
F	6
G	11/16
H	4
I	7-1/8
J	9-11/16
K	13-1/8

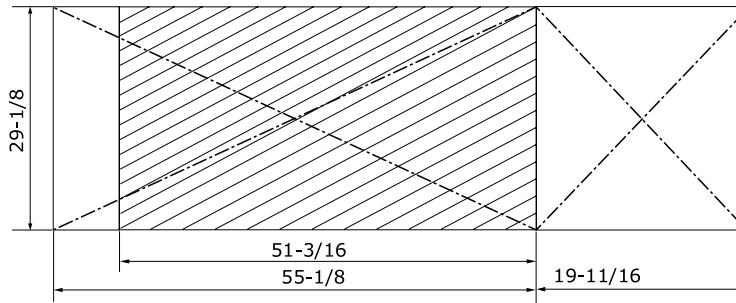
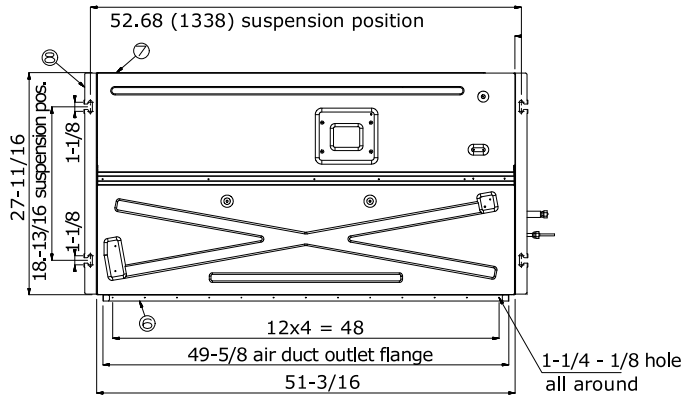
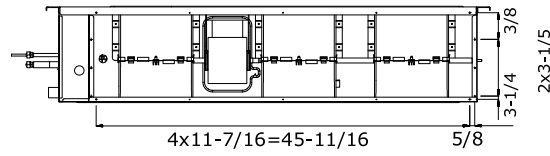


No.	Name	Description
1	Liquid pipe connection	4TVL0018B100N*: 1/4 4TVL0024B100N*: 3/8
2	Gas pipe connection	4TVL0018B100N*: 1/2 4TVL0024B100N*: 5/8
3	Drain pipe connection	OD 1 (25), ID 0.78
4	Drain pipe connection (optional drain pump)	OD 1 (25), ID 0.78
5	Power supply/communications connection	—
6	Air discharge grill flange	—
7	Air filter	—
8	Mounting hooks	3/8 or M10

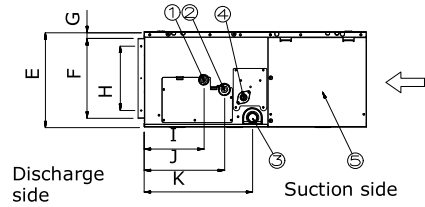
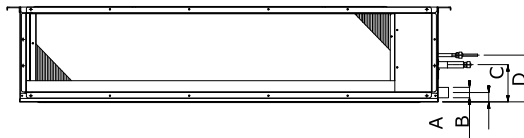
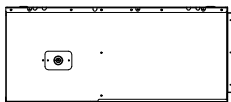
# Preparing for Installation

4TVL0030B100N\*  
 4TVL0036B100N\*  
 4TVL0048B100N\*

Unit: inch



A	1
B	1-1/8
C	4-9/16
D	5-3/4
E	11-5/8
F	9-3/4
G	11/16
H	2x4=8
I	7-5/16
J	9-13/16
K	13-1/4

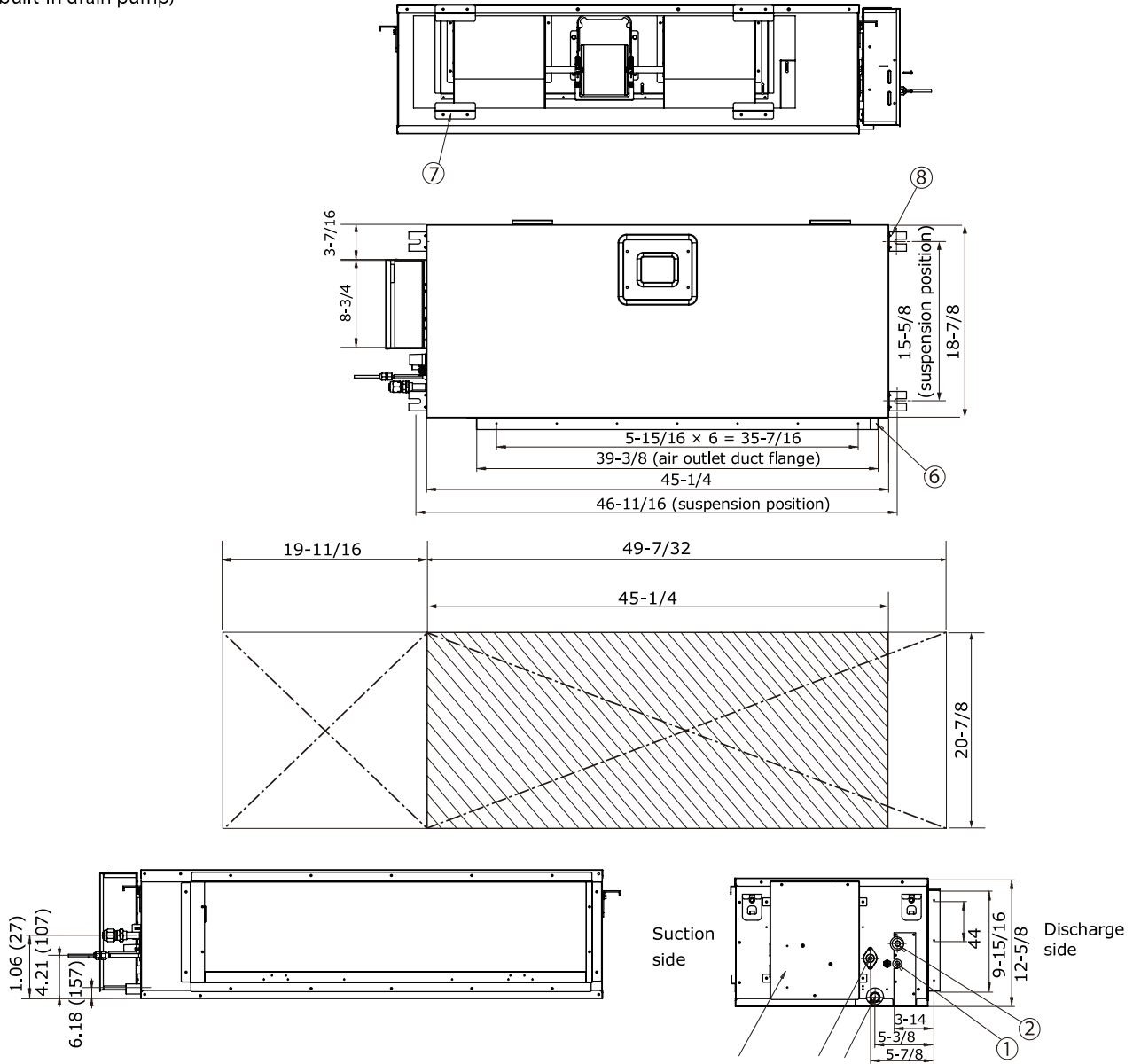


No.	Name	Description
1	Liquid pipe connection	3/8
2	Gas pipe connection	5/8
3	Drain pipe connection	OD 1, ID 0.78
4	Drain pipe connection (optional drain pump)	OD 1, ID 0.78
5	Power supply/communications connection	—
6	Air discharge grill flange	—
7	Air filter	—
8	Mounting hooks	3/8 or M10

## Preparing for Installation

4TVD0007C100N\* 4TVD0009C100N\* 4TVD0012C100N\*  
 4TVD0015C100N\* 4TVD0018C100N\* 4TVD0054C100N\*  
 (built-in drain pump)

Unit: inch

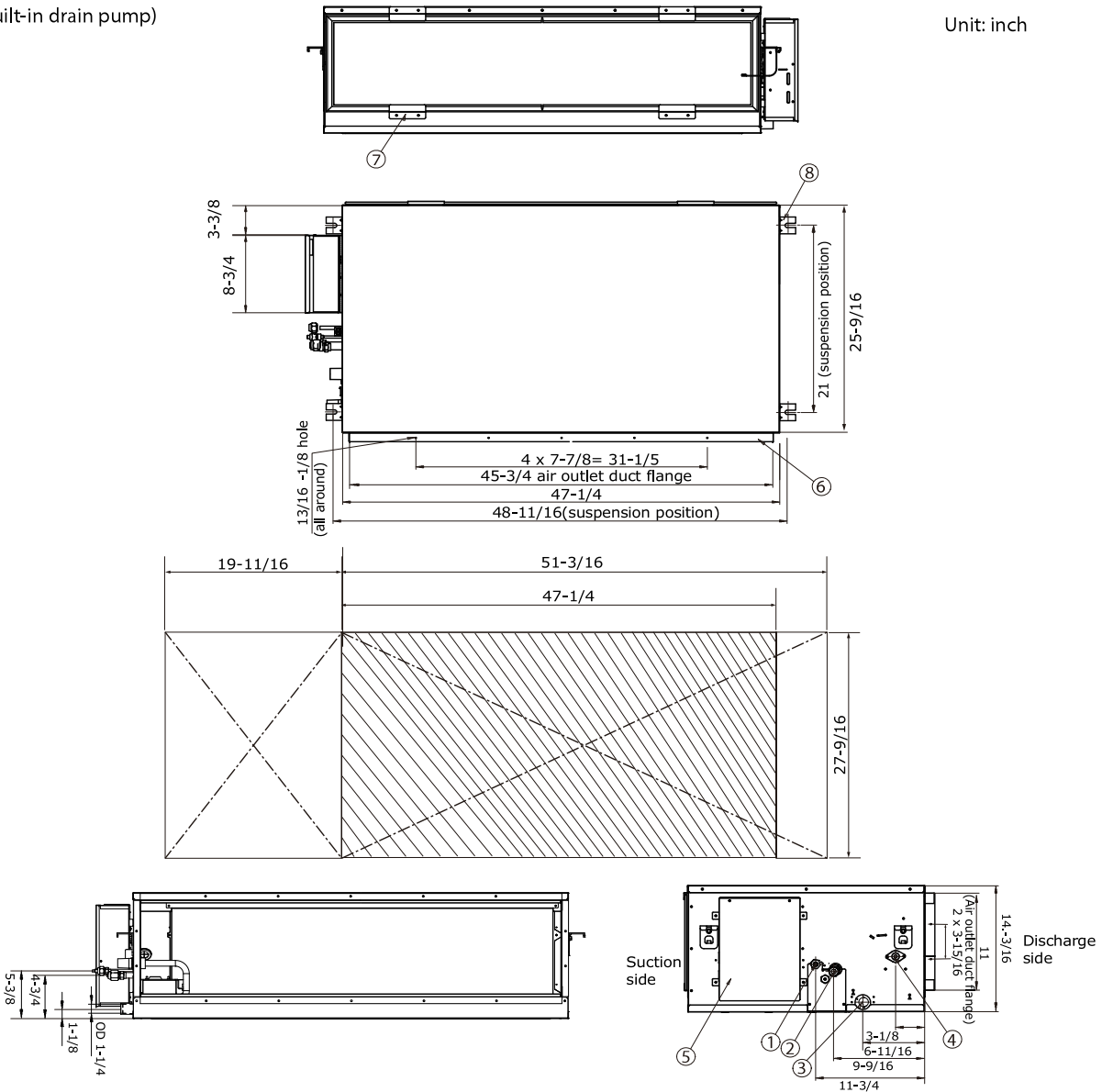


No.	Name	Description
1	Liquid pipe connection	1/4
2	Gas pipe connection	1/2
3	Drain pipe connection	OD 1 , ID 0.78
4	Drain pipe connection (optional drain pump)	OD 1 , ID 0.78
5	Power supply/communications connection	—
6	Air discharge grill flange	—
7	Air filter	—
8	Mounting hooks	3/8 or M10

# Preparing for Installation

4TVD0024C100N\* 4TVD0027C100N\* 4TVD0030C100N\*  
 4TVD0036C100N\* 4TVD0048C100N\*  
 (built-in drain pump)

Unit: inch



No.	Name	Description
1	Liquid pipe connection	3/8
2	Gas pipe connection	5/8
3	Drain pipe connection	OD 1, ID 0.78
4	Drain pipe connection (optional drain pump)	OD 1, ID 0.78
5	Power supply/communications connection	—
6	Air discharge grill flange	—
7	Air filter	—
8	Mounting hooks	3/8 or M10

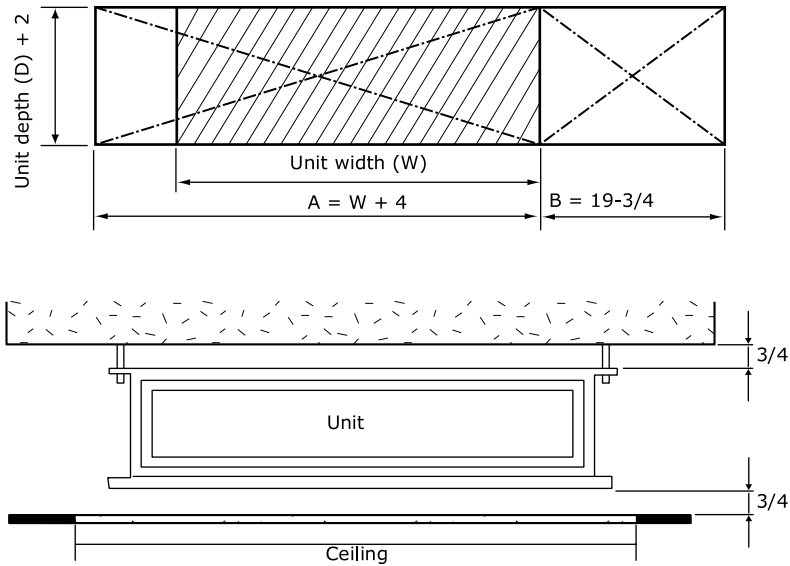
## Service Clearances

### ⚠ CAUTION

#### Avoid Contact with Fan Motor Blower!

Failure to follow instructions below could result in minor to moderate injury or equipment damage.

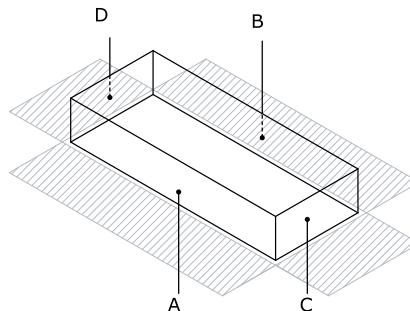
Install the unit at least 7.54 ft (2.2 m) from the floor to avoid the possibility of contact with the fan motor blower while cleaning the duct.



**Note:** If the unit is installed in a ceiling that does not have removable tiles, make allowances for servicing the unit by creating an access hole. If the unit is installed more than 39-3/8 in. above the floor, the access hole must be the size of "B." If the unit is installed less than 39-3/8 in. above the floor, the access hole must be the size of "A" + "B" both.

## Unit Insulation for High-Humidity Applications

For high-humidity applications, insulate the unit prior to mounting it. Use the following guidelines:



## Preparing for Installation

Indoor unit		Insulation (Unit: inch)	
		A and B	C and D
Slim duct	4TVL0007B100N*	35-3/8 x 7-7/8	23-5/8 x 7-7/8
	4TVL0009B100N*		
	4TVL0012B100N*		
	4TVL0018B100N*	43-5/16 x 7-7/8	23.6 (600) x 7-7/8
	4TVL0024B100N*		
	4TVL0030B100N*	51-3/16 x 11-13/16	27-3/16 x 11-13/16
	4TVL0036B100N*		
4TVL0048B100N*			
MSP duct (built-in drain pump)	4TVD0007C100N*	45-5/16 x 480	480 x 320
	4TVD0009C100N*		
	4TVD0012C100N*		
	4TVD0015C100N*		
	4TVD0018C100N*	47-3/16 x 25-9/16	25-9/16 x 360
	4TVD0024C100N*		
	4TVD0027C100N*		
	4TVD0030C100N*		
	4TVD0036C100N*		
	4TVD0048C100N*		
4TVD0054C100N*			
<b>Note:</b> Use an insulation thickness of at least 3/8 in.			

# Installation

Review “Location Considerations” before proceeding with the installation.

Follow the procedures in these sections in the order given.

**Notes:**

- Install the Y-joint before installing the indoor unit.
- Remove the two shipping cushions underneath the blower housings (models 4TVD0024/27/30/36/48C100NC) before installing the unit.

## Mounting the Unit

If the ceiling is already constructed, piping must be laid into position before placing the unit inside the ceiling.

**⚠ WARNING**

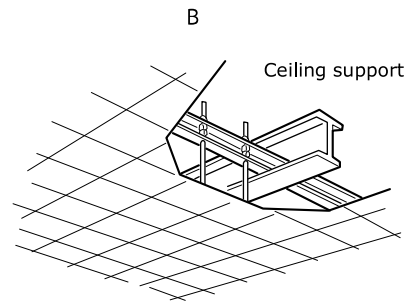
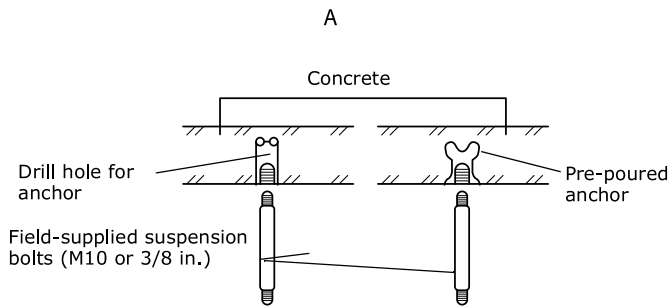
**Mounting Integrity!**  
Failure to follow instruction below could result in death or serious injury or possible equipment or property-only damage.  
Ensure the roof structure supports are strong enough to support the weight of the unit and any accessories.

To mount the unit:

1. Place the template on the spot where the unit is to be installed and mark the holes.

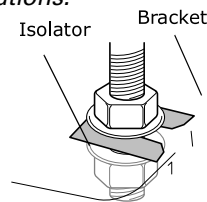
**Note:** The template may shrink or stretch slightly due to heat or humidity. Before drilling holes, verify proper dimensions between the marks.

2. Determine the appropriate type of suspension bolts and anchors according to the ceiling type. Insert bolt anchors into existing ceiling supports (A) or construct a suitable support (B).



3. Install suspension bolts at all four locations.
4. Screw two nuts to each suspension bolt, leaving space between the nuts for hanging the unit.

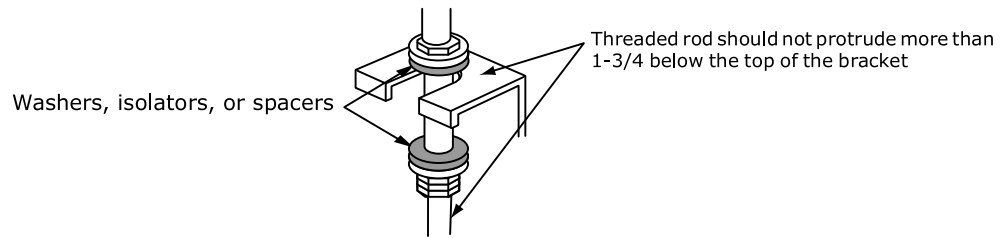
**Note:** If the suspension bolts are longer than 59 in. or vibrations are a concern, place isolators on the brackets to absorb vibrations.



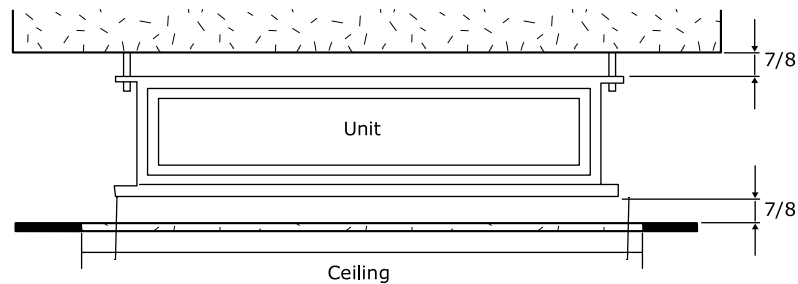
5. Hang the unit by its support brackets between the two nuts.

## Installation

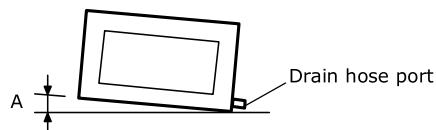
6. If pad stoppers or isolators are used to absorb vibrations, place them on the brackets.
7. Tighten the nuts to suspend the unit following the guidelines in the figure below.



8. Maintain proper spacing between the unit and the ceiling; refer to the following figure.



9. Adjust the level of the unit so that it tilts 1° to the side of the unit that will be connected to the drain hose. A tilt of 1° is also recommended when a drain pump is installed.



Model	A
Slim duct	1/8 in.
MSP duct	3/8 in.

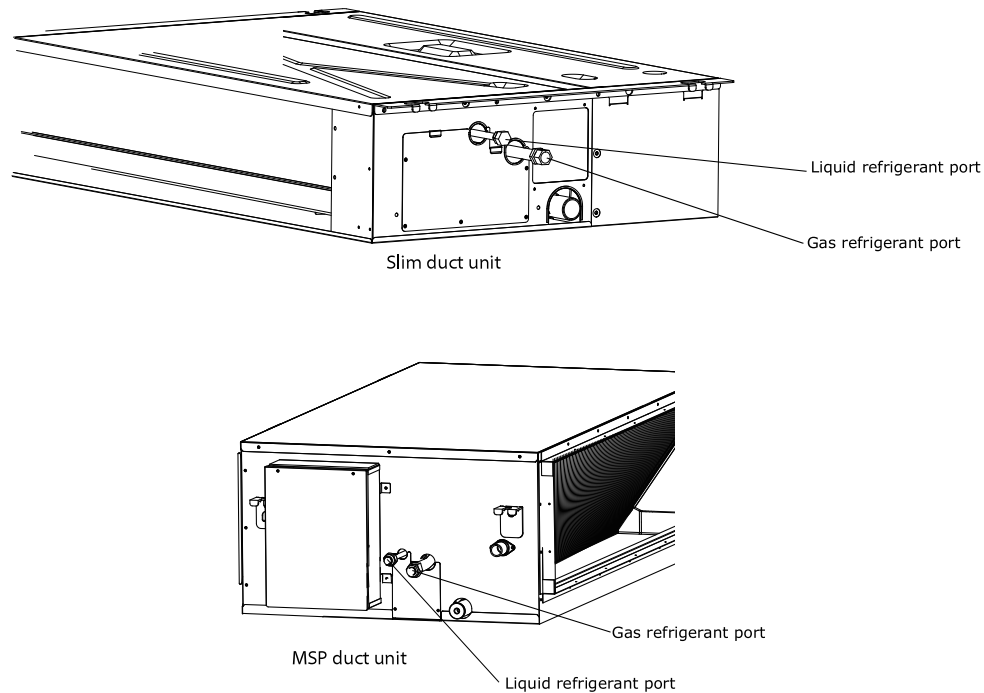
## Purging the Unit

The unit is shipped from the factory with a holding charge of nitrogen. All of this gas must be purged from the unit.

To purge the unit, unscrew the pinch pipes from the ends of both gas and liquid refrigerant pipes. Make sure all gas has escaped before connecting the piping.

**Note:** To prevent dirt or foreign objects from getting into the pipes during installation, do not remove the pinch pipes completely until you are ready to connect the piping.





## Installing Refrigerant Piping

Connect field-supplied piping using flared connections (not supplied) or by brazing. The large unit port is for gas refrigerant; the small one is for liquid refrigerant. Cut or extend field-supplied piping as needed. Use the following procedures.

### NOTICE

#### System Damage!

Failure to follow this procedure could result in system damage.

If brazing is used for connecting pipes, a nitrogen purge is required to prevent the formation of copper oxides inside the piping.

- Before connecting the pipes, make sure they are free of dirt and debris.
- Use insulated, unwelded, degreased, and deoxidized copper pipe (Cu-DHP type according to ISO 1337 or UNI EN 12735-1) suitable for an operating pressure of at least 609.15 psi and a burst pressure of at least 3002.28 psi. Copper pipe for hydro-sanitary applications is unsuitable.
- For sizing and limits (height difference, line length, maximum bends, refrigerant charge, and so on) see the outdoor unit installation manual.
- All refrigerant connections must be accessible for servicing and maintenance.

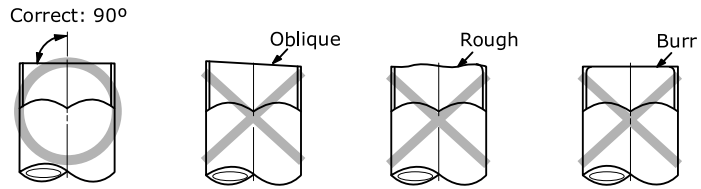
## Pipe Cutting

Required tools:

- Pipe cutter
- Reamer
- Pipe holder

1. Using a pipe cutter, cut the pipe so that the cut edge is at 90° to the side of the pipe.
2. Use a reamer to remove all burrs at the cut edge.

See examples of correctly and incorrectly cut pipes.



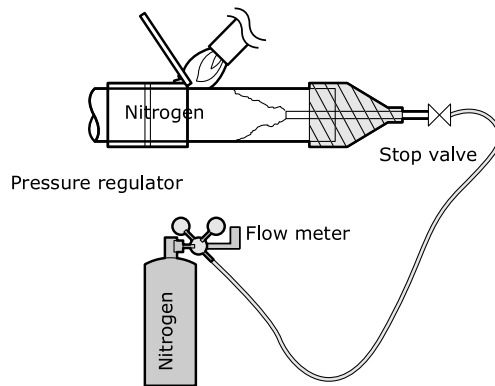
## Nitrogen Flushing While Brazing

**NOTICE**

**Avoid Unit Damage!**  
Failure to follow instruction below could result in damage to the unit, capacity loss, and reduced long-term reliability.  
**Do not braze pipe connections without performing nitrogen flushing.**

While brazing refrigerant pipes, flush them with nitrogen gas. Use a pressure regulator to maintain a flow rate of 1.76 ft<sup>3</sup>/h or more.

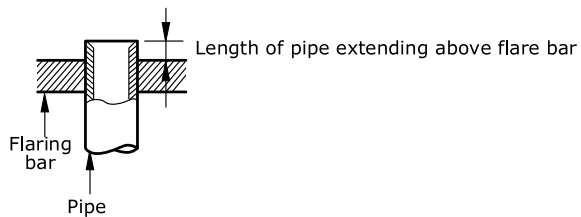
**Figure 1. Nitrogen flushing while brazing refrigerant pipes**

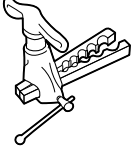



## Flared Pipe Connections

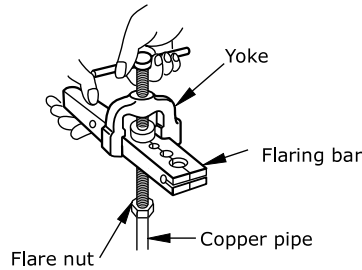
Clutch type and wing nut type flare tools are available for flared pipe connections.

1. Slide the flare nut over the pipe to be flared.
2. Slide the end of the pipe into the hole on the flaring bar that fits the pipe, leaving a length of pipe, determined by tool type (see table), extending above the flaring bar. Clamp it down.



R-410A clutch type	Conventional flare tool	
	Clutch type	Wing nut type
0–0.020 in.	0.04–0.06 in.	0.6–0.08 in.
		

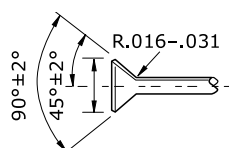
- Attach the yoke to the flaring bar, centering the conical part over the end of the pipe that is extending above the flaring bar.
- Tighten the yoke securely to flare the end of the pipe.



- Remove the pipe. The end of the pipe that you flared should look like the end of a trumpet. See examples of correctly and incorrectly flared pipes.



- Align the pipes and tighten the flare nuts manually and then with a spanner torque wrench, applying the torque according to pipe dimensions:

Outer diameter in.	Connection torque (ft·lb)	Flare dimension (in.)	Flare shape (in.)
1/4	10.3–13.3 ft·lb	0.34–0.36	
3/8	25.1–31.0 ft·lb	0.50–0.52	
1/2	36.1–45.0 ft·lb	0.64–0.65	
5/8	50.2–60.5 ft·lb	0.76–0.78	

## Leak Testing Pipe Connections

Before leak testing pipe connections, read all safety precautions and notes.

### **⚠ WARNING**

#### **Confined Space Hazards!**

Failure to follow instructions below could result in death or serious injury.

Do not work in confined spaces where refrigerant or other hazardous, toxic or flammable gas may be leaking. Refrigerant or other gases could displace available oxygen to breathe, causing possible asphyxiation or other serious health risks. Some gases may be flammable and or explosive. If a leak in such spaces is detected, evacuate the area immediately and contact the proper rescue or response authority.

### **⚠ WARNING**

#### **Explosion Hazard!**

Failure to follow safe leak test procedures below could result in death or serious injury or equipment or property-only-damage.

Never use an open flame to detect gas leaks. Use a leak test solution for leak testing.

### **⚠ WARNING**

#### **Explosion Hazard!**

Failure to follow these instructions could result in death or serious injury or equipment or property-only damage.

Use only dry nitrogen with a pressure regulator for pressurizing unit. Do not use acetylene, oxygen or compressed air or mixtures containing them for pressure testing. Do not use mixtures of a hydrogen containing refrigerant and air above atmospheric pressure for pressure testing as they may become flammable and could result in an explosion. Refrigerant, when used as a trace gas should only be mixed with dry nitrogen for pressurizing units.

### **⚠ WARNING**

#### **Explosion Hazard!**

Failure to follow instruction below could result in death or serious injury.

Do not exceed unit nameplate design pressures when leak testing system.

### **NOTICE**

#### **Refrigerant Pipe Damage!**

Overfilling the refrigerant pipe with nitrogen could result in pipe damage.

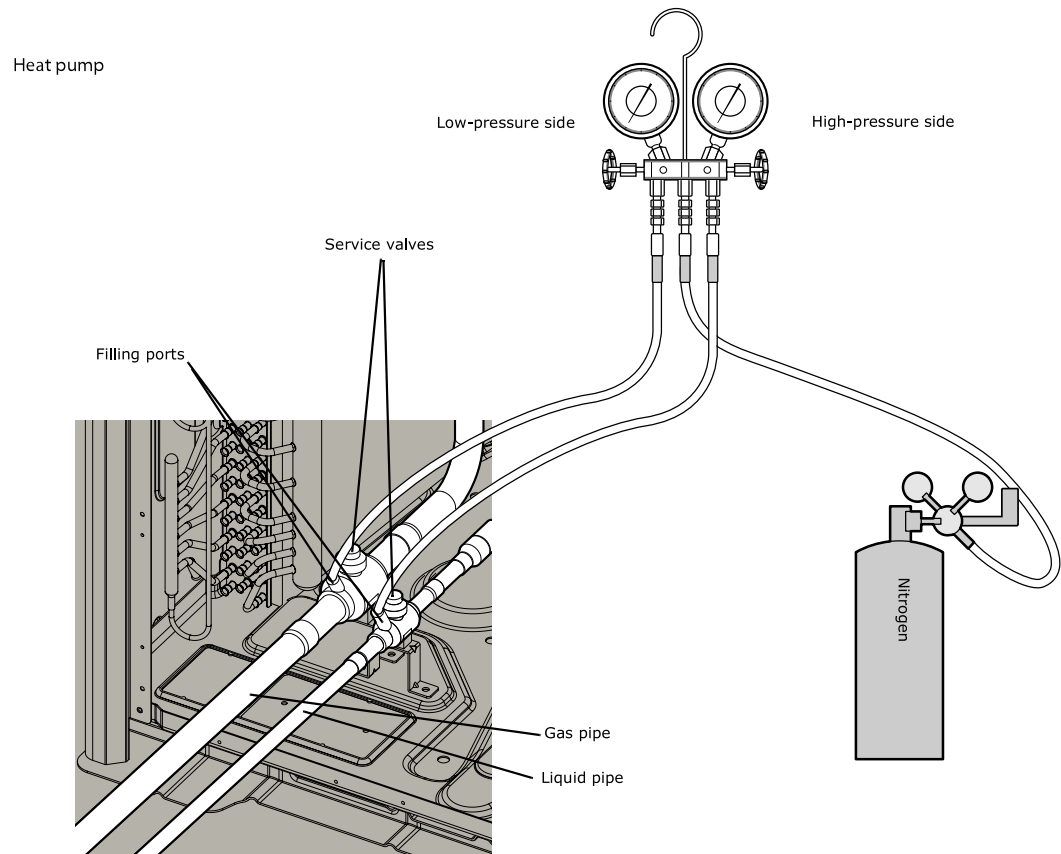
When performing a leak test, use a pressure regulator to prevent an excess amount of nitrogen (over 594.6 psi [4.1 MPa]) from entering the pipe.

- All required pipe leak testing must be completed in accordance with national and/or local codes.
- Use R-410A refrigerant gas as a tracer for leak detection.
- Use oil-pumped dry nitrogen to develop required test pressures.
- Use tools rated for R-410A refrigerant.
- Perform the leak test with the outdoor unit service valves closed.
- Do not remove the Schrader core from the service valves.
- Leak test only one circuit at a time to minimize system exposure to potentially harmful moisture in the air.

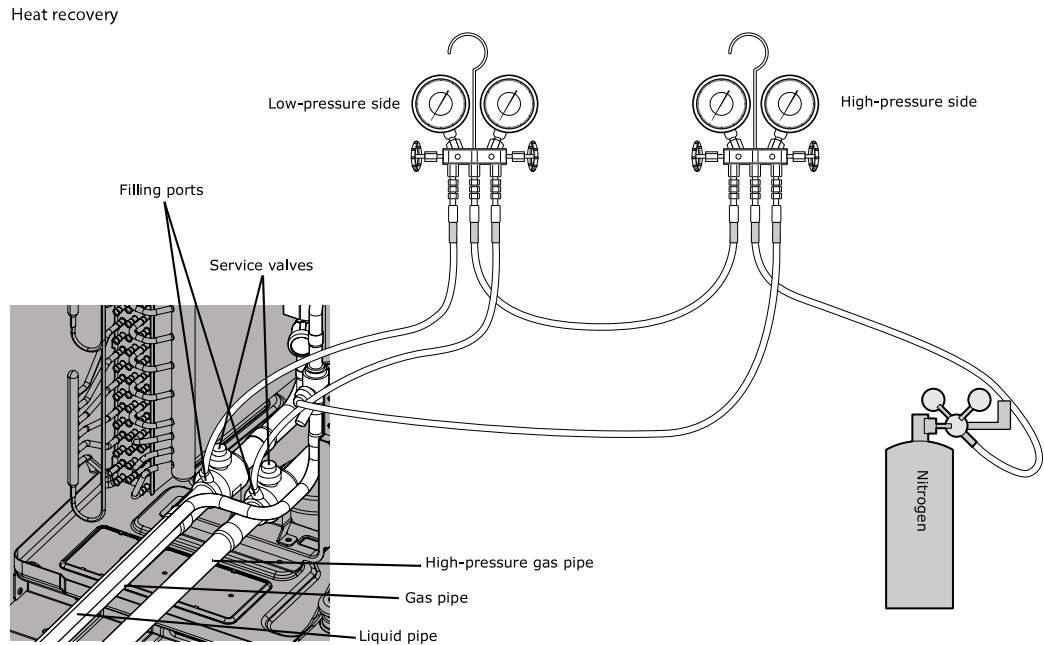
To perform the test:

1. Connect the refrigerant manifold gauge hoses to the liquid side and gas side service ports on the unit, and connect the center hose to a nitrogen gas tank fitted with a pressure regulator (see [Figure 2](#), p. 21 and [Figure 3](#), p. 22).
2. Fill the lines with nitrogen as described:
  - To 72 psi for 5 minutes.
  - Then, to 220 psi for 5 minutes.
  - Then, to 590 psi for 24 hours.
3. If the pressure drops for any reason other than verifiable temperature fluctuations, check for leaks and repair them. Use soapy water to check for leaks; bubbles will form if joints are not tight.
4. Release pressure in pipelines gradually.
5. Repair leaks.
6. Repeat the previous steps until the pressure remains constant at 145 psi for at least 15 minutes.
7. When testing is finished, remove hoses from service ports.

**Figure 2. Leak testing pipe connections: Heat pump**

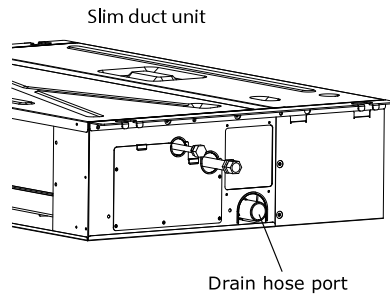
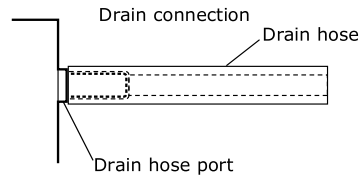


**Figure 3. Leak testing pipe connections: Heat recovery**

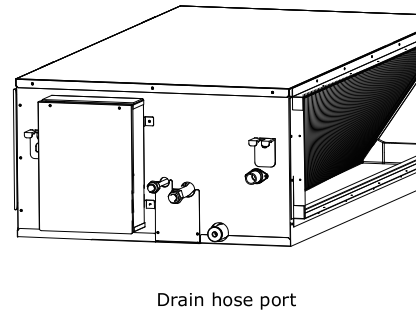


## Installing the Drain System

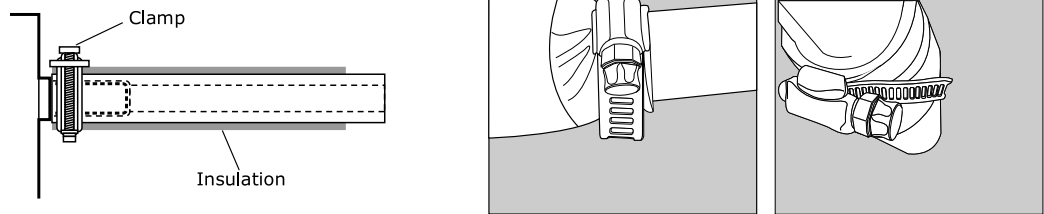
1. Push the supplied drain hose as far as possible over the drain hose port.
  - Do not apply excessive force to the piping on the unit side when connecting the drain hose.
  - Drain hose port locations differ depending on the unit type.



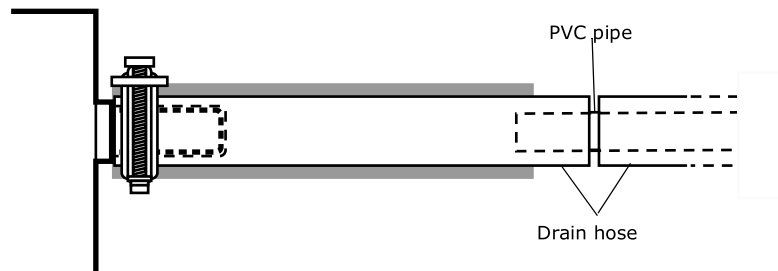
MSP duct unit



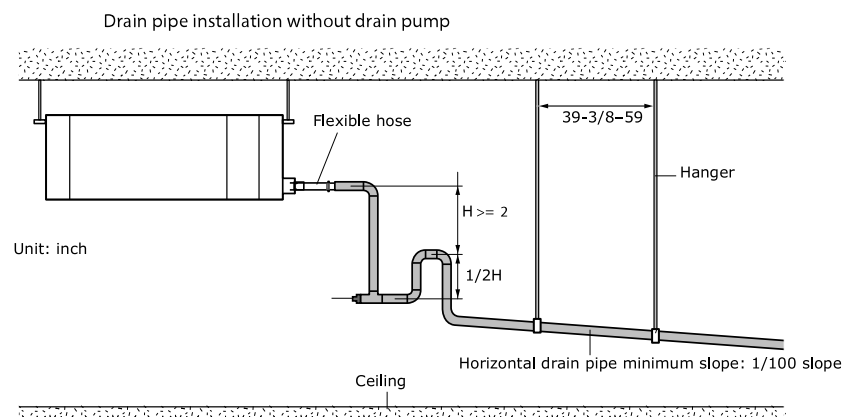
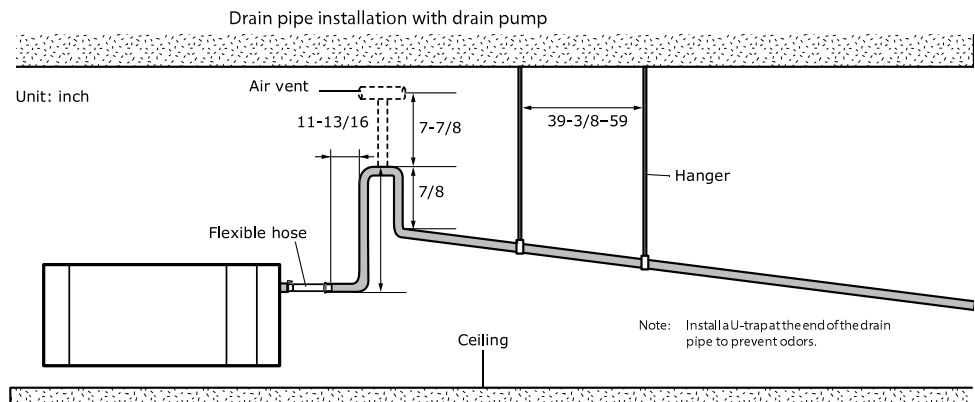
2. Wrap the insulation (supplied) around the drain hose and clamp the connection as tightly as possible until you can see at least 8 holes.



3. Install the drain pipe into the drain hose. Secure it with PVC adhesive and clamps as necessary to ensure a tight fit with no leakage.



4. Refer to appropriate figure for installing the drain pipe with out without a drain pump.

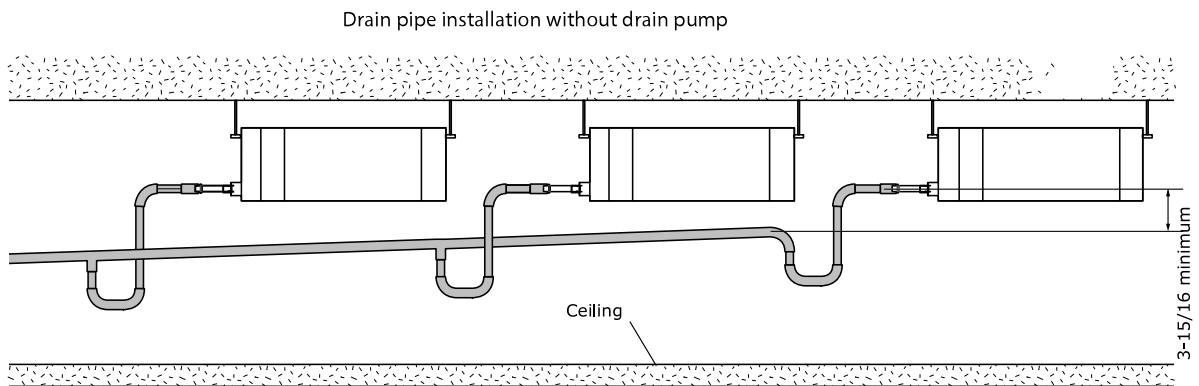
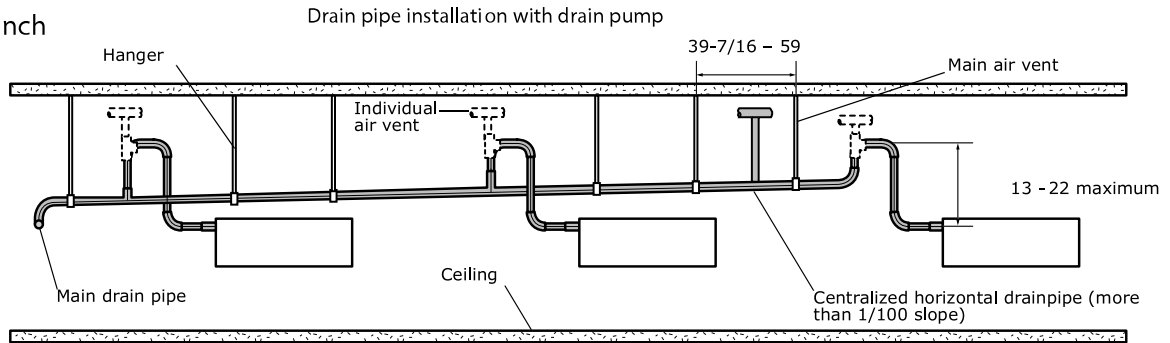


## Centralized Drainage

If the installation requires more than three indoor units, install the main air vent at the front of the indoor unit that is farthest from the main drain. It may be necessary to install individual air vents to prevent water flowing back to each indoor unit.

For installations without a drain pump, install U-traps at the end of the drain pipe for each unit. See figures below.

Unit: inch

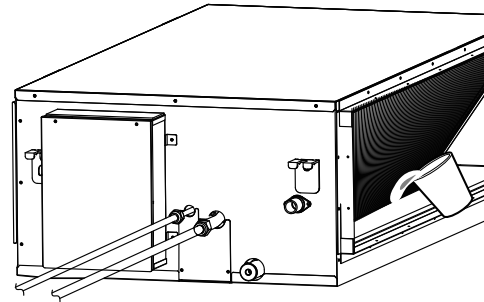
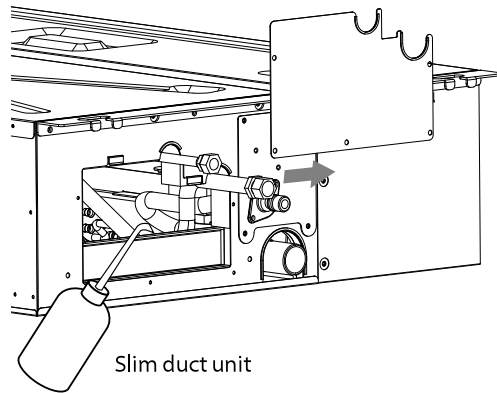


## Testing the Drainage

After completing the installation, test the drainage to make sure there are no leaks:

1. Operate the unit in cool mode.
2. Remove drain pump cover.
3. Squirt water into the drain pan (see figure).





4. Confirm that the water flows out through the drain hose and that no leakage occurs at any of the connections.
5. Reassemble the drain pump cover.

# Insulation

After determining that there are no leaks in the refrigerant pipes or drainage hose, insulate them as described in the following sections.

## Insulating Refrigerant Pipes

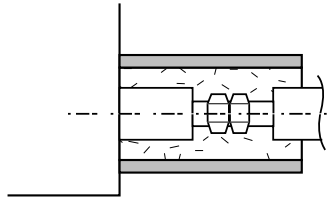
- Use the table below to select the insulation size according to pipe size.

Pipe	Pipe size (in.)	Insulation, EPDM or NBR (in.)	
		Standard conditions (86°F [30°C], 85%)	High humidity conditions <sup>(a)</sup> (86°F [30°C], 85%)
Liquid pipe	1/4 - 3/8	3/8	3/8
	1/2 - 2	1/2	1/2
Gas pipe <sup>(b)</sup>	1/4		3/4
	3/8 - 1	1	
	1-1/8 - 1-3/4	1	1-1/4
	2		1-1/2

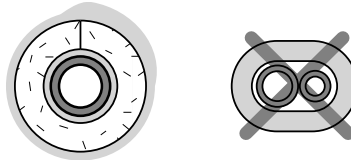
<sup>(a)</sup> When installing insulation in any of the following environments, use insulation required for high humidity conditions: Buildings with close proximity to bodies of water or hot springs or on the side of a hill in which the building is partly covered by earth; ceilings frequently exposed to moisture such as in restaurants, saunas, swimming pools, and corridors of dormitories or studios near a frequently-used outdoor exit; buildings with no ventilation system.

<sup>(b)</sup> Internal temperature of gas pipe is higher than 248°F (120°C).

- Wrap insulation around the entire surface of each pipe, from the indoor unit to the outdoor unit, overlapping insulation to avoid gaps. Clamp insulation tightly to pipe.



- Do not wrap the gas and liquid refrigerant pipes together.



- Avoid compressing the insulation as much as possible.
- Be sure there are no cracks or deformities in the insulation at bends in pipes.
- If necessary double the insulation to prevent condensation from forming in warm or humid areas.
- Cut off excess insulation.

## Insulating the Drainage System

Insulate (field supplied) the entire surface of the drain pipe that is inside the building, including the connection between the drain hose and drain stub. Clamp tightly.

# Wiring the Unit

## ⚠ WARNING

### Hazardous Voltage!

Failure to disconnect power before servicing could result in death or serious injury. Disconnect all electric power, including remote disconnects before servicing. Follow proper lockout/tagout procedures to ensure the power can not be inadvertently energized. Verify that no power is present with a voltmeter.

## NOTICE

### Use Copper Conductors Only!

Failure to use copper conductors could result in equipment damage as unit terminals are not designed to accept other types of conductors.

- Make all electrical connections in accordance with electrical codes and ordinances.
- Select the power cable in accordance with relevant local and national regulations.
- Wire size must comply with local and national code.
- Use grade H07RN-F or H05RN-F power cable.
- Connect the power cable into the power cable terminal and fasten it with a clamp.
- Unbalanced power must be maintained within 10% of supply rating among whole indoor units.
- Significantly unbalanced power may shorten the life of the system. If the unbalanced power is greater than 10% of supply rating, the unit will stop and an error code will be generated.
- Connect the power cable to the auxiliary circuit breaker. An all-pole disconnection from the power supply must be incorporated in the field wiring (1/8 in.).
- All wiring must be protected from weather and damage.
- Maintain a distance of 2 in. or more between power and communications cables to prevent interference.
- Maintain a voltage drop of less than 10% between the power source and the unit(s).
- Use an appropriate screwdriver for tightening the terminal screws. A screwdriver with a small head will strip the head and make proper tightening impossible.
- Over-tightening the terminal screws may break them.
- Tightening torque for M4 screws: 0.86–1.06 lbf-ft.
- After making a knockout hole, apply rust-preventive paint to the bare metal around the hole.
- Secure the cable conduit to the outdoor knockout using the proper connector and bushing.

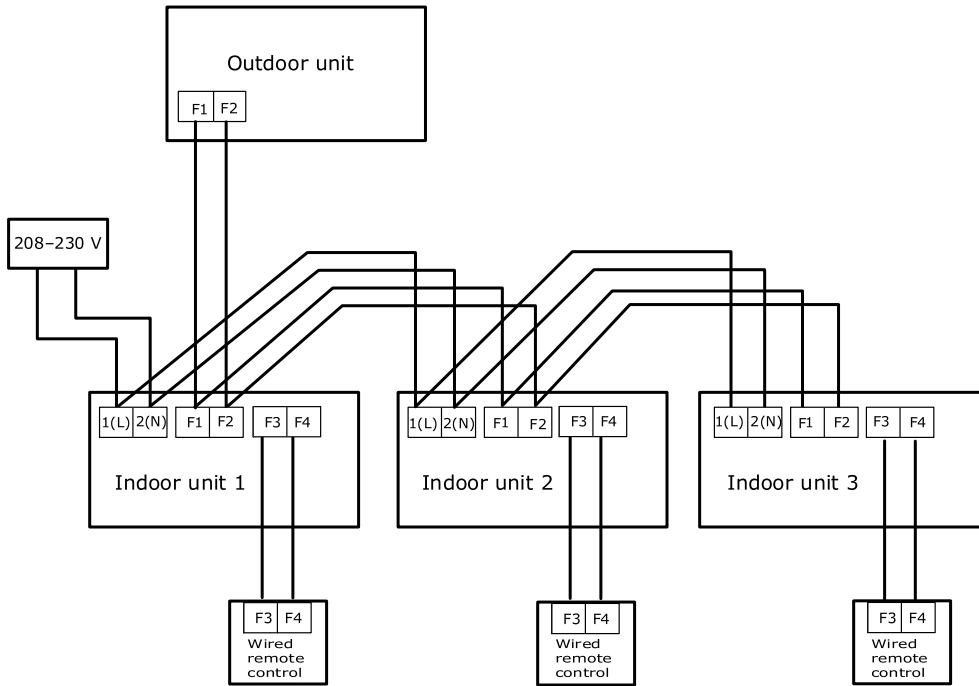
## Power Wiring

Connect the power cable to terminals 1(L) and 2(N) on each indoor unit. Refer to the following wiring diagrams.

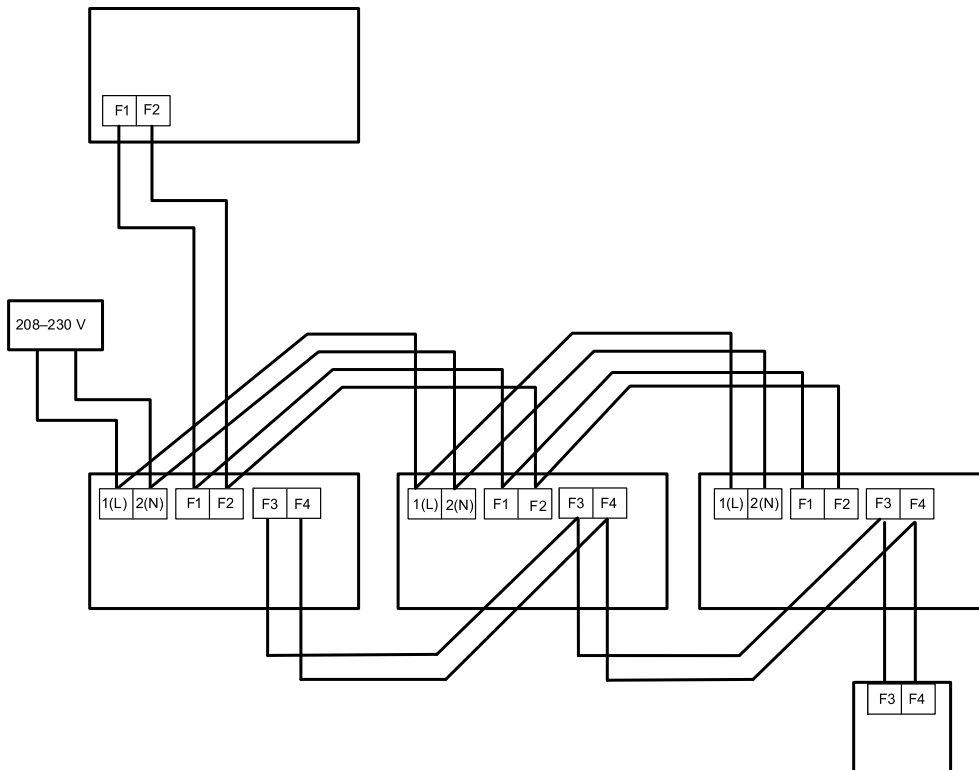
## Communications Wiring

Use 18 AWG, 25 pF/ft nom., 60.7  $\Omega$  impedance, braid or foil shielded, twisted pair for communications wiring. Connect the communications cable from the outdoor unit to the indoor unit at terminals F1 and F2. Refer to the following wiring diagrams.

**Figure 4. Wiring diagram for individual control**



**Figure 5. Wiring diagram for group control**



# Configuration

All indoor units are factory configured. If modifications are required. The VRF Technician Utilities Tool (TUT) is strongly recommended. However, any of the following devices can be used:

- Technician Utilities Tool (TUT) (instructions follow)
- Wireless Remote Control (instructions follow)
- Wired Remote Control (refer to VRF-SVN59\* for instructions)

**Note:** Configuration changes are not required for typical installations.

## Using the Technician Utilities Tool (TUT)

To change configurations using the VRF Technician Utilities Tool (TUT), follow this procedure:

1. At the Indoor Unit Option Writer screen on the TUT, select the desired option codes by referring to [Table 1, p. 31](#) and [Table 2, p. 34](#).

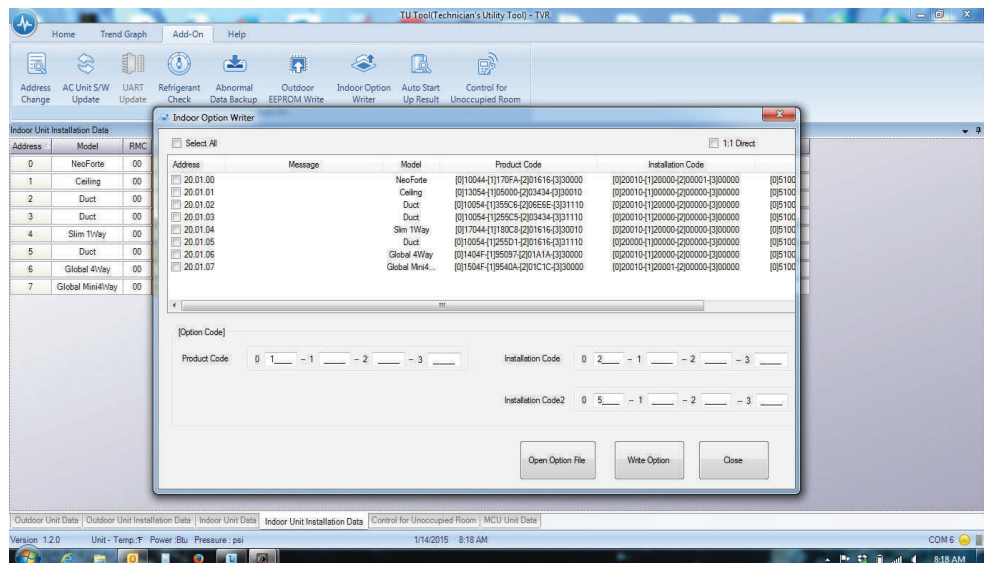
In addition, use the following table and notes to determine which digits can be modified:

	Digit	1	2	3	4	5	6	7	8	9	10	11	12
Installation Option #1	[0]	2	0	0	1	0	[1]	0	0	0	0	0	0
	[0]	5	0	0	0	0	[1]	0	0	0	0	0	0
	Digit	13	14	15	16	17	18	19	20	21	22	23	24
Installation Option #1	[2]	0	0	0	0	0	[3]	0	0	0	0	0	0
	[2]	0	0	0	0	0	[3]	0	0	0	0	0	0

### Notes:

1. Digits 1, 7, 13 and 19 (in brackets) are factory set and cannot be changed.
2. For Installation Option #1, digit 2 will always be "2". See [Table 1, p. 31](#) for the option code settings.
3. For Installation Option #2, digit 2 will always be "5". See [Table 2, p. 34](#) for the option code settings.
4. Digits shown in black boxes are currently not used and should always be set to "0".

2. To save your settings, select the **Write Option** button. See the figure below for an example of the Indoor Unit Option Writer screen on the TUT.

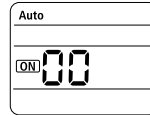


## Using the VRF Wireless Remote Control

To change configurations of the VRF system using the VRF Wireless Remote Control, follow this procedure:

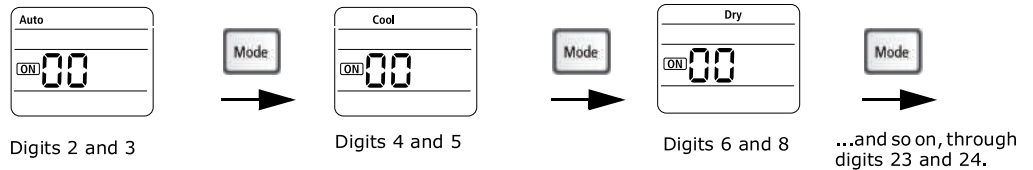
1. Remove the batteries from the remote control, and re-insert them while simultaneously pressing the Temp+ and Temp- buttons (refer to Figure 6, p. 30).

The first 2-digit segment of a 24-digit sequence will appear on the wireless remote control display, as shown:



2. To advance to the next 2-digit segment, press the Mode button (Figure 6, p. 30). Continue pressing the Mode button until the two-digit segment appears that corresponds to the option setting or address setting you want to view or change.

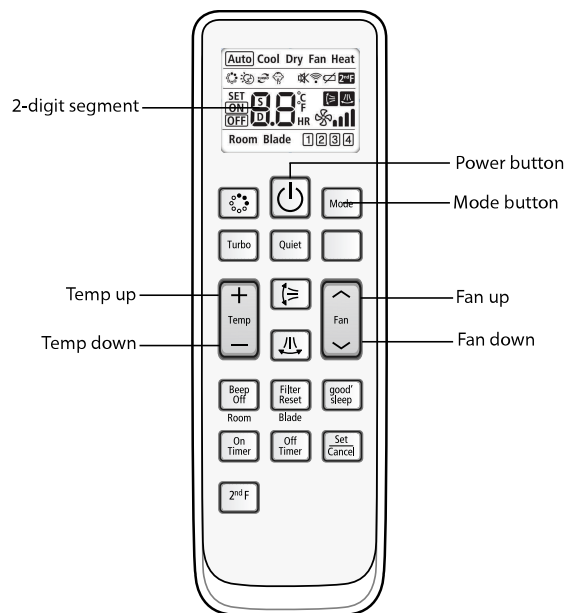
Each 2-digit segment is differentiated from the others by a combination of operation mode (Auto/Cool/Dry...) and ON/OFF icons, as shown below. (See "The 2-Digit Segments," for more detailed information.)



**Note:** Digits 1, 7, 13, and 19 do not appear and are not used for configuration.

3. To change the value of the left digit on the display, press the Fan down button.  
**Note:** Values and their corresponding settings are listed in the following pages of this section of the manual.
4. To save the setting, press the Power button twice.
5. To restore the wireless remote control to normal operating mode, remove the batteries from the remote control. Then re-insert them.

**Figure 6. Wireless remote control**

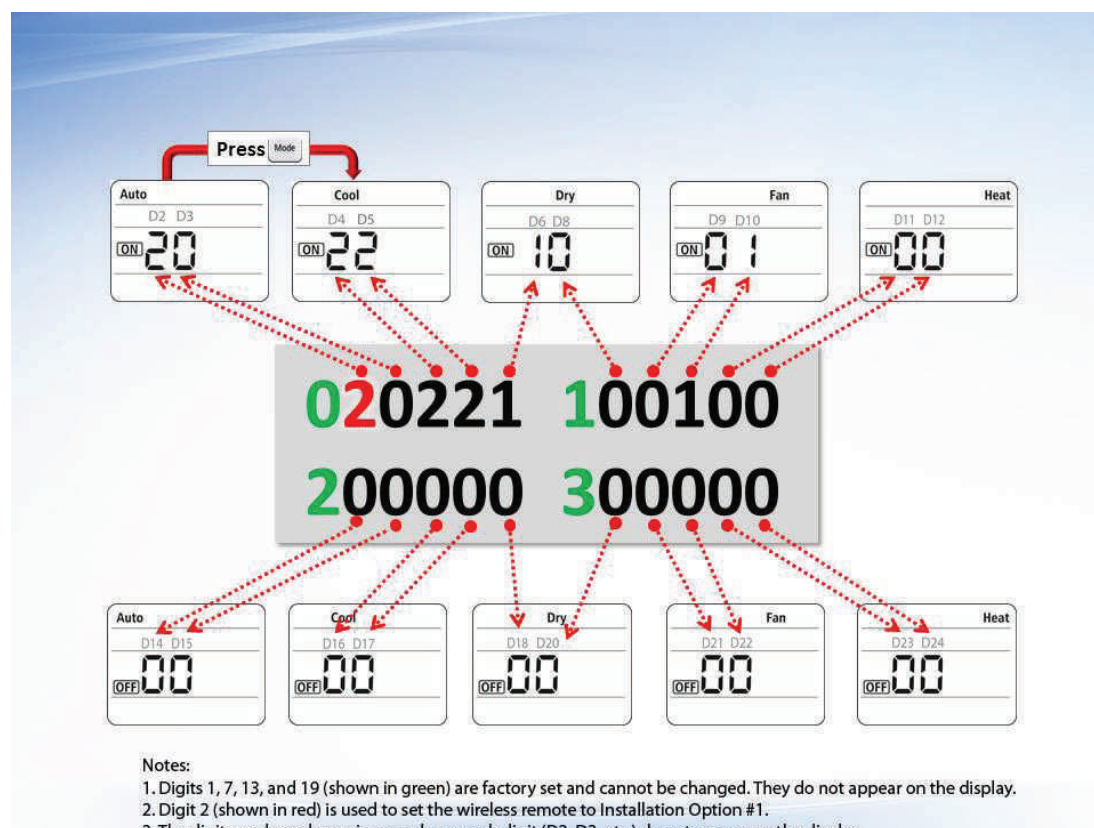


## The 2-Digit Segments

Each 2-digit segment is differentiated from the others by a combination of operation mode and timer on/off icons as shown in Figure 7, p. 31.

Use digit 2 (shown in red in Figure 7, p. 31) to set the wireless remote to Installation Option #1.

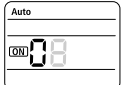
Figure 7. Two-digit segments in the 24-digit sequence



## Installation Option #1

When digit 2 is set to a value of "2," the options shown in Table 1, p. 31 can be set to the values in the right column.

Table 1. Installation option #1: Digit 2 = 2

Display screen (mode and On/Off)	Digit	Option description	Set digit to...
N/A	1	Factory set to 0	Cannot be changed. Not seen in configuration mode.
	2	Installation option #1	2

# Configuration

**Table 1. Installation option #1: Digit 2 = 2 (continued)**

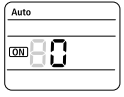
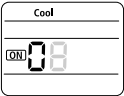
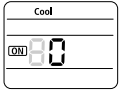
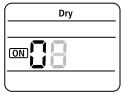
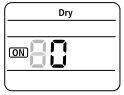
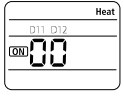
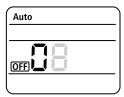
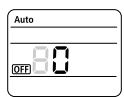
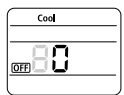
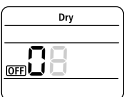
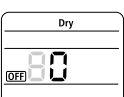
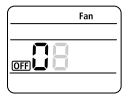
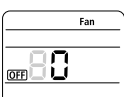
Display screen (mode and On/Off)	Digit	Option description	Set digit to...
	3	Evaporator drying	0: Disabled 1: Disabled 2: Enabled (5 min) 3: Disabled (5 min) 4: Enabled (10 min) 5: Disabled (10 min) 6: Enabled (30 min) 7: Disabled (30 min)  <b>Note:</b> When Cooling or Dry mode stops, the indoor fan continues to operate for the number of minutes indicated by each setting.
	4	Remote temperature sensor/ minimizing fan operation when unit is Thermo Off	<b>Remote temperature sensor</b> 0: Disabled 1: Enabled 2: Disabled 3: Enabled 4: Disabled 5: Enabled 6: Disabled 7: Enabled 8: Disabled 9: Enabled A: Disabled B: Enabled  <b>Minimize fan operation when thermostat is off</b> Disabled Disabled Enabled (Heating) <sup>(a)</sup> Enabled (Heating) <sup>(a)</sup> Enabled (Cooling) <sup>(a)</sup> Enabled (Cooling) <sup>(a)</sup> Enabled (Heating/Cooling) <sup>(a)</sup> Enabled (Heating/Cooling) <sup>(a)</sup> Enabled (Cooling Ultra Low Fan) <sup>(a)</sup> Enabled (Cooling Ultra Low Fan) <sup>(a)</sup> Enabled (Heating/Cooling Ultra Low Fan) <sup>(a)</sup> Enabled (Heating/Cooling Ultra Low Fan) <sup>(a)</sup>
	5	Central control	0: Disabled 1: Enabled
	6	RPM up	0: Disabled 1: Enabled
N/A	7	Factory set to 1	Cannot be changed. Not seen in configuration mode.
	8	Drain pump	0: Disabled 1: Enabled (no delay) 2: Enabled (3-min delay)
	11	Adjusted EEV position of Thermo Off unit	0: Default EEV position 1: Reduced EEV position
N/A	13	Factory set to 2	Cannot be changed. Not seen in configuration mode.
	14	External control relay	0: Disabled 1: On/Off control 2: Off-only control 3: Window on/off control
	15	External control output/ External heater signal/ Cooling operation signal/ Free cooling control signal <sup>(b)</sup>	0: External control (Thermo On) 1: External control (Operation On) 2: External heater signal (Fan on) <sup>(c)</sup> 3: External heater signal (Fan off) <sup>(d)</sup> 4: Cooling operation signal <sup>(e)</sup> 5: Free Cooling control (Cooling Thermo On) 6: Free Cooling control (Cooling/Dry Thermo On)



Table 1. Installation option #1: Digit 2 = 2 (continued)

Display screen (mode and On/Off)	Digit	Option description	Set digit to...														
	17	Buzzer	0: Enabled 1: Disabled														
	18	Filter timer (hours of use)	2: 1000 6: 2000														
N/A	19	Factory set to 3	Cannot be changed. Not seen in configuration mode.														
	20	Associating wireless remote control with indoor unit(s)	0, 1: Channel 1 2: Channel 2 3: Channel 3 4: Channel 4														
	21	Heat setting compensation	<table border="0"> <tr> <td><b>Heat setting compensation</b></td> <td><b>Removing condensate in heating mode<sup>1</sup></b></td> </tr> <tr> <td>0: Disabled</td> <td>Disabled</td> </tr> <tr> <td>1: 3.6°F (2°C)</td> <td>Disabled</td> </tr> <tr> <td>2: 9°F (5°C)</td> <td>Disabled</td> </tr> <tr> <td>3: Disabled</td> <td>Enabled</td> </tr> <tr> <td>4: 3.6°F (2°C)</td> <td>Enabled</td> </tr> <tr> <td>5: 9°F (5°C)</td> <td>Enabled</td> </tr> </table> <p><sup>1</sup>The fan operates (20 min. maximum), even after the indoor unit is turned off, to remove condensate from an indoor unit that has switched from cooling to heating mode. This applies to drain pump models only.</p>	<b>Heat setting compensation</b>	<b>Removing condensate in heating mode<sup>1</sup></b>	0: Disabled	Disabled	1: 3.6°F (2°C)	Disabled	2: 9°F (5°C)	Disabled	3: Disabled	Enabled	4: 3.6°F (2°C)	Enabled	5: 9°F (5°C)	Enabled
<b>Heat setting compensation</b>	<b>Removing condensate in heating mode<sup>1</sup></b>																
0: Disabled	Disabled																
1: 3.6°F (2°C)	Disabled																
2: 9°F (5°C)	Disabled																
3: Disabled	Enabled																
4: 3.6°F (2°C)	Enabled																
5: 9°F (5°C)	Enabled																
	22	Adjusted EEV position of Thermo Off unit during oil return/defrost mode	0: Default EEV position 1: Reduced EEV position														

- (a) Minimizes fan operation when unit is Thermo Off. Fan operates for 20 seconds at an interval of 5 minutes in Heat mode. Fan stops or operates in Ultra Low in Cooling mode when unit is Thermo Off.
- (b) Digit 15 requires that an external contact interface module be connected. Refer to VRF-SVN54.
- (c) When used as external heater On/Off signal, the fan runs continually when the external heater is On.
- (d) When used as external heater On/Off signal, the fan is Off when the external heater is On with indoor unit in Cooling Only. (For Cooling Only mode, install the mode selector (TVCTRLTCMC2000) on the outdoor unit and set it to Cooling mode.) If the fan is set to Off and the unit is in Cooling Only mode, an external sensor or wired remote controller is required to detect the current indoor temperature.
- (e) When the indoor unit is in Cooling or Dry mode, the contacts are closed.

## Installation Option #2

**⚠ WARNING**

**Fire Hazard!**  
 Failure to follow instructions below could result in death or serious injury, and property damage.  
 Do not install an electric heater in the airflow channel of a ducted VRF indoor unit.

When digit 2 is set to a value of "5," the options shown in the following table can be changed to the values in the right column.

## Configuration

**Table 2. Installation option #2: Digit 2 = 5**

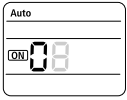
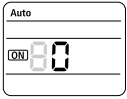
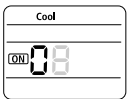
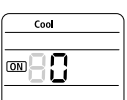
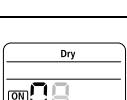
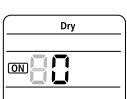
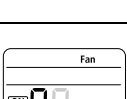
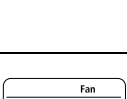
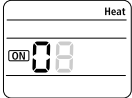
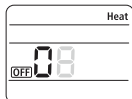
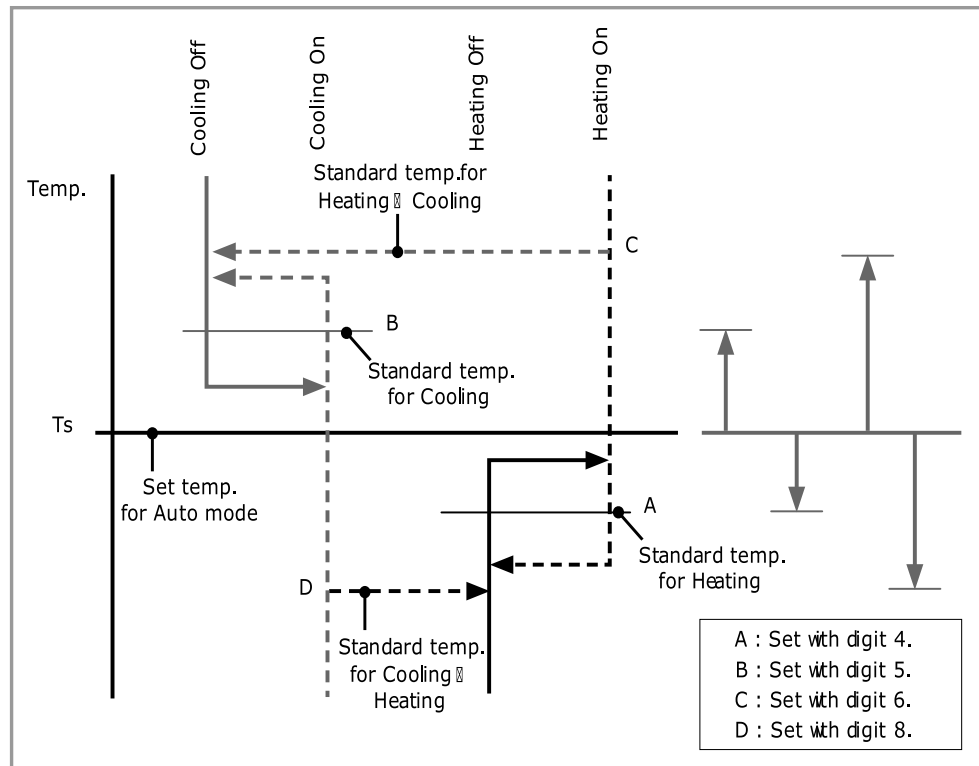
Display screen (mode and On/Off)	Digit	Option description	Set digit to...
N/A	1	Factory set to 0	Cannot be changed. Not seen in configuration mode.
	2	Installation option #2	5
	3	Auto Changeover (Heat Recovery or Cooling Only)	0: Follow product option 1: Auto Changeover enabled (see <a href="#">Figure 8, p. 36</a> <sup>(a)</sup> . 2: Cooling Only enabled (see <a href="#">Figure 8, p. 36</a> ) <sup>(b)</sup> .
	4	Heat deadband <b>Note:</b> Applies only when digit 3 is set to "1" (Auto Changeover mode is enabled).	0: Disabled 1: 0.9°F (0.5°C) 2: 1.8°F (1.5°C) 3: 2.7°F (1.5°C) 4: 3.6°F (2°C) 5: 4.5°F (2.5°C) 6: 5.4°F (3°C) 7: 6.3°F (3.5°C)
	5	Cooling deadband <b>Note:</b> Applies only when digit 3 is set to "1" (Auto Changeover mode is enabled).	0: Disabled 1: 0.9°F (0.5°C) 2: 1.8°F (1.5°C) 3: 2.7°F (1.5°C) 4: 3.6°F (2°C) 5: 4.5°F (2.5°C) 6: 5.4°F (3°C) 7: 6.3°F (3.5°C)
	6	Standard for Auto Changeover (Heating to Cooling) <b>Note:</b> Applies only when digit 3 is set to "1" (Auto Changeover mode is enabled).	0: 1.8°F (15°C) 1: 2.7°F (1.5°C) 2: 3.6°F (2°C) 3: 4.5°F (2.5°C) 4: 5.4°F (3°C) 5: 6.3°F (3.5°C) 6: 7.2°F (4°C) 7: 8.1°F (4.5°C)
N/A	7	Factory set to 1	Cannot be changed. Not seen in configuration mode.
	8	Standard for Auto Changeover (Cooling to Heating) <b>Note:</b> Applies only when digit 3 is set to "1" (Auto Changeover mode is enabled).	0: 1.8°F (15°C) 1: 2.7°F (1.5°C) 2: 3.6°F (2°C) 3: 4.5°F (2.5°C) 4: 5.4°F (3°C) 5: 6.3°F (3.5°C) 6: 7.2°F (4°C) 7: 8.1°F (4.5°C)
	9	Time required for mode change <b>Note:</b> Applies only when digit 3 is set to "1" (Auto Changeover mode is enabled).	0: 5 minutes 1: 7 minutes 2: 9 minutes 3: 11 minutes 4: 13 minutes 5: 15 minutes 6: 20 minutes 7: 30 minutes
	10	Compensation option for height or pipe length difference between indoor units.	0: Use default value 1: Use when height or pipe length difference is as specified. <sup>(c)</sup> 2: Use when height or pipe length difference is as specified. <sup>(d)</sup>
N/A	13	Factory set to 2	Cannot be changed. Not seen in configuration mode.

Table 2. Installation option #2: Digit 2 = 5 (continued)

Display screen (mode and On/Off)	Digit	Option description	Set digit to...
	18(e)	Control variables for auxiliary heat <b>Important:</b> See fire hazard warning (at the top of this table) regarding improper installation location of an electric auxiliary heater in ducted indoor units.	<p><b>Set temperature for auxiliary heat On</b></p> <p>0: No temperature offset 1: No temperature offset 2: No temperature offset 3: 2.7°F (1.5°C) 4: 2.7°F (1.5°C) 5: 2.7°F (1.5°C) 6: 5.4°F (3.0°C) 7: 5.4°F (3.0°C) 8: 5.4°F (3.0°C) 9: 8.1°F (4.5°C) A: 8.1°F (4.5°C) B: 8.1°F (4.5°C) C: 10.8°F (6.0°C) D: 10.8°F (6.0°C) E: 10.8°F (6.0°C)</p> <p><b>Time delay for auxiliary heat On</b></p> <p>No delay 10 minutes 20 minutes No delay 10 minutes 20 minutes No delay 10 minutes 20 minutes No delay 10 minutes 20 minutes No delay 10 minutes 20 minutes</p> <p><b>Note:</b> If further temperature offsets are desired, contact technical support.</p>
N/A	19	Factory set to 3	Cannot be changed. Not seen in configuration mode.
	23	Forcing fan operation for heating and cooling	<p><b>Cooling: Fan Setting</b></p> <p>0: Disabled 1: Disabled 2: Disabled 3: Disabled 4: Enabled (Fan: user setting) 5: Enabled (fan: user setting) 6: Enabled (Fan: user setting) 7: Enabled (Fan: user setting) 8: Enabled Fan: High 9: Enabled (Fan: High) A: Enabled (Fan: High) B: Enabled (Fan : High) C: Enabled (Fan: Low) D: Enabled Fan: Low E: Enabled (Fan: Low) F: Enabled (Fan: Low)</p> <p><b>Heating: Fan Setting</b></p> <p>Disabled Enabled (Fan: User setting) Enabled (Fan: High) Enabled (Fan: Low) Disabled Enabled (Fan: User setting) Enabled (Fan: High) Enabled (Fan: Low) Disabled Enabled (Fan: User setting) Enabled (Fan: High) Enabled (Fan: Low) Disabled Enabled (Fan: User setting) Enabled (Fan: High) Enabled (Fan: Low)</p>

- (a) Up to 8 IDUs can be accommodated on a single MCU port under the following conditions: IDUs cannot exceed 54 MBH, mode master control must be used, wired controllers must be used.
- (b) Cooling Only operation (HR only) must be selected on HR systems that have a direct connection (no MCU) to main liquid and gas lines.
- (c) Height difference between the indoor unit being configured and the lowest indoor unit is > 98.4 ft, or pipe length difference between the outdoor unit and the furthest indoor unit and the outdoor unit and the indoor unit being configured is > 360.9 ft
- (d) Height difference between the indoor unit being configured and the lowest indoor unit is 49.2–98.4 ft, or pipe length difference between the outdoor unit and the furthest indoor unit and the outdoor unit and the indoor unit being configured is 164–360.9 ft. **Example:** If the unit being configured is 60 ft away from the outdoor unit, and the furthest in door unit is 300 ft from the outdoor unit, the pipe length difference is 240 ft (300-60=240), so Digit 10 should be set to "2."
- (e) Heater operation when Installation Option #1 digit 15 is set to enable external heater. Set Installation Option #2 digit 18 to desired offset (see external contact control board installation instructions: VRF-SVN54\*).

Figure 8. Heat recovery unit operating in Auto Changeover mode



Note: Minimum compressor off time for heating or cooling is set by Digit 9.

## Discharge Air Temperature

When using discharge air temperature control:

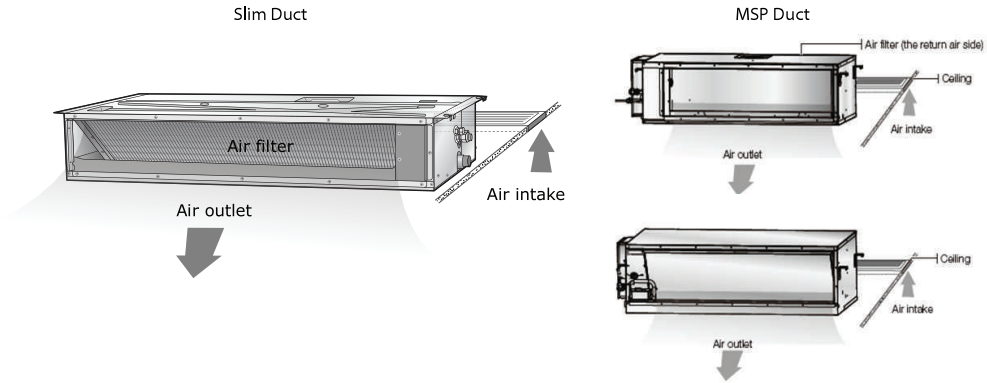
- The target discharge air temperature setpoint can be set using the wired remote controller (refer to the wired remote controller installation guide: VRF-SVN59).
- The discharge air temperature adjusts to meet the discharge air temperature setpoint only when the indoor unit is enabled. The indoor unit is enabled by the remote temperature sensor and is based on the space temperature setpoint.
- External conditions and or protective controls may prevent the discharge air temperature control from satisfying the discharge air temperature setpoint.

**Note:** Discharge air temperature control for ducted units can also be enabled using the VRF System Controller (note does not apply to AHU kit).

# Operation

Familiarize yourself with the unit components and operating tips before operating the unit.

## Components



*Note: Your unit and display may look slightly different from the illustration shown above, depending on the model.*

## Operating Tips

<b>Cooling</b>	If the outside temperature is much higher than the selected indoor temperature, it may take longer than expected to achieve the desired temperature. Avoid making extreme changes in the temperature setting. This practice wastes energy and does not cool the room faster.
<b>Heating</b>	Because the unit heats the room by removing heat energy from outdoor air, the heating capacity may decrease when outdoor temperatures are extremely low. If the unit provides insufficient heat, use an additional heating source in combination with the unit.
<b>Defrost</b>	When the unit runs in Heat mode, frost may form due to the temperature difference between the unit and the outside air. If this happens: <ul style="list-style-type: none"> <li>• The unit stops heating.</li> <li>• The unit will operate automatically in Defrost mode for 10 minutes.</li> <li>• The steam produced on the outdoor unit in Defrost mode is safe.</li> </ul> No intervention is required; after about 10 minutes, the unit will resume normal operation. The unit will not operate when it starts to defrost.
<b>Fan</b>	The fan may not operate for 3–5 minutes after turning on the unit, to prevent cold air from blowing on occupants while the unit is warming up.
<b>High indoor and outdoor temperature</b>	If both indoor and outdoor temperatures are high and the unit is running in Heat mode, the outdoor unit fan and compressor may stop at times. This is normal; wait until the unit turns on again.
<b>Power failure</b>	A power failure will cause the unit to stop operating. When power returns, the unit will automatically resume operation.
<b>Minimum off timer</b>	If the unit has just been turned on, it will not produce cool/warm air for 3 minutes. This delay mechanism protects the outdoor unit compressor.

## Internal Protections

Internal protections operate if an internal fault occurs in the unit.

## Operation

Type	Description
Cold air dump	The internal fan will be off to prevent a cold air dump when the heat pump is in defrost mode.
Defrost cycle	The internal fan will be off to prevent a cold air dump when the heat pump is in defrost mode.
Anti-short cycle timer	The compressor observes a 3-minute off time when cycling power to the unit or after an outage.

**Note:** If the heat pump is operating in Heat mode, a defrost cycle is activated to remove frost from an outdoor unit that may have accumulated at low temperatures. The internal fan is switched off automatically and restarted only after the defrost cycle is completed.

## Operating Ranges

For efficient use, operate the unit within the ranges shown in this table.

Mode	Outdoor temperature	Indoor temperature	Indoor humidity
Cooling	23°F (-5°C) to 118°F (48°C)	64°F (18°C) to 90°F (32°C)	80% or less
Heating	-4°F (-20°C) to 75°F (24°C)	81°F (27°C) or less	—
Drying	23°F (-5°C) to 118°F (48°C)	64°F (18°C) to 90°F (32°C)	—

**Note:** The standard temperature for heating is 45°F (7°C). If the outdoor temperature drops to 32°F (0°C) or below, the heating capacity can be reduced depending on the temperature condition. If the indoor cooling temperature is set higher than 90°F (32°C), the unit will not cool to its full capacity.

## Operating Mode for Heat Pump Systems

For heat pump systems, the main indoor unit controls whether the system operates in heating or cooling. If the main indoor unit calls for heating and sub-indoor units call for cooling, the main indoor unit (and any other sub-indoor units that call for heating) will operate in heating mode, and the sub-indoor units that call for cooling will do nothing.

## External Static Pressure Configuration Settings

The configuration settings in the following table correspond to unit model and static pressure value.

**Note:** The factory default setting is the lowest value for each model.

Model	Static pressure		Configuration setting
	in H <sub>2</sub> O	mmAq	
4TVL0007B100N*	0	0	010054-1254AE-201616-331110
	0.04	1	010054-1255D1-201616-331110
	0.08	2	010054-1255D1-201616-331110
	0.16	4	010054-125904-201616-331110
4TVL0009B100N*	0	0	010054-121913-201C1C-331110
	0.04	1	010054-121946-201C1C-331110
	0.08	2	010054-121946-201C1C-331110
	0.16	4	010054-121979-201C1C-331110

Model	Static pressure		Configuration setting
	in H <sub>2</sub> O	mmAq	
4TVL0012B100N*	0	0	010054-121946-202323-331110
	0.04	1	010054-121979-202323-331110
	0.08	2	010054-121979-202323-331110
	0.16	4	010054-1219AC-202323-331110
4TVL0018B100N*	0	0	010054-1259BA-203434-331110
	0.04	1	010054-1259ED-203434-331110
	0.08	2	010054-1259ED-203434-331110
	0.16	4	010054-125E10-203434-331110
4TVL0024B100N*	0	0	010054-125D2D-204848-331110
	0.04	1	010054-125E50-204848-331110
	0.08	2	010054-125E50-204848-331110
	0.16	4	010054-125E83-204848-331110
4TVL0030B100N*	0	0	010054-1B5915-205A5A-331110
	0.04	1	010054-1B5948-205A5A-331110
	0.12	3	010054-1B599F-205A5A-331110
	0.24	6	010054-1B5AE4-205A5A-331110
4TVL0036B100N*	0	0	010054-1B5956-206E6E-331110
	0.04	1	010054-1B5989-206E6E-331110
	0.12	3	010054-1B5AD0-206E6E-331110
	0.24	6	010054-1B5E25-206E6E-331110
4TVL0048B100N*	0	0	010054-1B59B9-209191-331110
	0.04	1	010054-1B59EC-209191-331110
	0.12	3	010054-1B5E33-209191-331110
	0.24	6	010054-1B5E88-209191-331110
4TVD0007C100N*	0.04	1	010054-1B5095-201616-331110
	0.12	3	010054-1B50F8-201616-331110
	0.20	5	010054-1B544B-201616-331110
	0.30	7.5	010054-1B549E-201616-331110
	0.40	10	010054-1B55D1-201616-331110
	0.50	12.5	010054-1B5913-201616-331110
4TVD0009C100N*	0.04	1	010054-1B5096-201C1C-331110
	0.12	3	010054-1B50FA-201C1C-331110
	0.20	5	010054-1B544D-201C1C-331110
	0.30	7.5	010054-1B5591-201C1C-331110
	0.40	10	010054-1B55E4-201C1C-331110
	0.50	12.5	010054-1B5917-201C1C-331110
	0.60	15	010054-1B595A-201C1C-331110

## Operation

Model	Static pressure		Configuration setting
	in H <sub>2</sub> O	mmAq	
4TVD0012C100N*	0.04	1	010054-1B50A6-202323-331110
	0.12	3	010054-1B5409-202323-331110
	0.20	5	010054-1B545C-202323-331110
	0.30	7.5	010054-1B54AF-202323-331110
	0.40	10	010054-1B55F2-202323-331110
	0.50	12.5	010054-1B5934-202323-331110
	0.60	15	010054-1B5967-202323-331110
4TVD0015C100N*	0.04	1	010054-1B50F9-202C2C-331110
	0.12	3	010054-1B544D-202C2C-331110
	0.20	5	010054-1B5580-202C2C-331110
	0.30	7.5	010054-1B55D3-202C2C-331110
	0.40	10	010054-1B5915-202C2C-331110
	0.50	12.5	010054-1B5968-202C2C-331110
	0.60	15	010054-1B59AB-202C2C-331110
4TVD0018C100N*	0.04	1	010054-1B542C-203535-331110
	0.12	3	010054-1B5570-203535-331110
	0.20	5	010054-1B55B4-203535-331110
	0.30	7.5	010054-1B5907-203535-331110
	0.40	10	010054-1B594A-203535-331110
	0.50	12.5	010054-1B599D-203535-331110
	0.60	15	010054-1B5AD0-203535-331110
4TVD0024C100N*	0.20	5.2	010054-1355A6-204646-331110
	0.30	7.5	010054-1355F9-204646-331110
	0.40	10	010054-13594E-204646-331110
	0.50	12.5	010054-135A70-204646-331110
	0.60	15	010054-135AA3-204646-331110
	0.70	17.5	010054-135AE6-204646-331110
	0.80	20	010054-135E18-204646-331110
4TVD0027C100N*	0.20	5.2	010054-1355C7-204F4F-331110
	0.30	7.5	010054-13591C-204F4F-331110
	0.40	10	010054-13595F-204F4F-331110
	0.50	12.5	010054-135A93-204F4F-331110
	0.60	15	010054-135AC5-204F4F-331110
	0.70	17.5	010054-135E08-204F4F-331110
	0.80	20	010054-135E3A-204F4F-331110



Model	Static pressure		Configuration setting
	in H <sub>2</sub> O	mmAq	
4TVD0030C100N*	0.20	5.2	010054-1355D8-205858-331110
	0.30	7.5	010054-13593A-205858-331110
	0.40	10	010054-13598E-205858-331110
	0.50	12.5	010054-135AB1-205858-331110
	0.60	15	010054-135AF4-205858-331110
	0.70	17.5	010054-135E37-205858-331110
	0.80	20	010054-135E59-205858-331110
4TVD0036C100N*	0.20	5.2	010054-135919-206969-331110
	0.30	7.5	010054-135A70-206969-331110
	0.40	10	010054-135AB4-206969-331110
	0.50	12.5	010054-135AF7-206969-331110
	0.60	15	010054-135E39-206969-331110
	0.70	17.5	010054-135E6C-206969-331110
	0.80	20	010054-135EAF-206969-331110
4TVD0048C100N*	0.20	5.2	010054-135A82-208D8D-331110
	0.30	7.5	010054-135AC5-208D8D-331110
	0.40	10	010054-135E18-208D8D-331110
	0.50	12.5	010054-135E5B-208D8D-331110
	0.60	15	010054-135E9F-208D8D-331110
	0.70	17.5	010054-135FB2-208D8D-331110
	0.80	20	010054-135FC5-208D8D-331110
4TVD0054C100N*	0.20	5.2	010054-135E07-209E9E-331110
	0.30	7.5	010054-135E4A-209E9E-331110
	0.40	10	010054-135E8D-209E9E-331110
	0.50	12.5	010054-135FB1-209E9E-331110
	0.60	15	010054-135FC4-209E9E-331110
	0.70	17.5	—
	0.80	20	—

# Maintenance

## Cleaning the Exterior

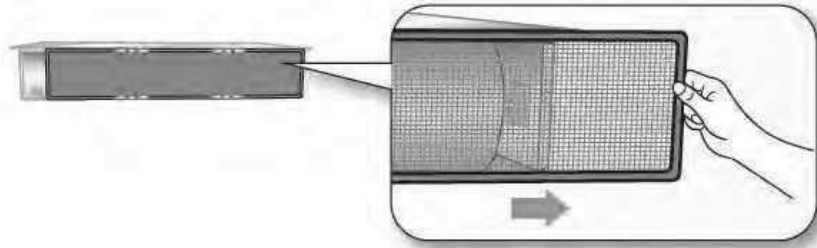
Use a dry or damp cloth to wipe the surface of the unit as needed. If necessary, use mild soap and water on a damp cloth. Use a soft brush to remove dirt from the coil.

**⚠ WARNING**

**Risk of Fire and Equipment Damage!**  
 Failure to follow instructions below could cause a fire which could result in death, serious injury, and equipment damage.  
 Do NOT use benzene or other flammable solvents to clean the unit. Wipe the unit with a dry or damp cloth. Use mild soap and water if necessary.

## Cleaning the Air Filter

1. The air filter is accessible from the back of the unit. Remove it by sliding it to the right.



2. Clean the air filter with a vacuum or soft brush. If the dust is too thick, rinse them under running water and dry in a well-ventilated area.  
*Note: Drying the air filter in a confined or humid area may cause odors to develop. If odors occur, re-clean and dry it in a well-ventilated area.*
3. Slide the air filter back to its original position.

## Periodic Maintenance Checks

Refer to the schedule given in [Table 3, p. 42](#) for proper unit maintenance.

**Note:** If the unit will not be used for an extended period of time, operate it in Fan mode for 3–4 hours to thoroughly dry it and then disconnect the power plug. Moisture left in the components can cause odors and internal damage.

**Table 3. Maintenance schedule**

Description	Monthly	Every 4 months	Annually	As needed
Clean the air filter as directed or when the filter indicator lights up on the remote controller. <sup>(a)</sup>	X			
Clean the condensate drain pan. <sup>(b)</sup>			X	
Thoroughly clean the heat exchanger. <sup>(b)</sup>			X	
Clean the condensate drain pipe. <sup>(b)</sup>		X		
Replace remote control batteries. <sup>(b)</sup>				X

<sup>(a)</sup> The described operations should be performed more frequently if the area of installation is very dusty.

<sup>(b)</sup> These operations must always be performed by qualified personnel. For more detailed information, see the installation manual for this unit.

# Troubleshooting

Refer to the following table for solutions to common problems.

**Table 4. Solutions to common problems**

Problem	Solution
The unit does not operate immediately after restarting it.	The anti-short cycle timer prevents the unit from operating immediately to keep it from overloading. The unit will start in 3 minutes.
The unit does not operate.	Verify the following: <ul style="list-style-type: none"> <li>• The main power is properly installed.</li> <li>• There has not been a power failure.</li> <li>• The circuit breaker is switched on/fuses are good.</li> </ul>
The temperature does not change.	Verify that the unit is not operating in Fan mode. If it is, select a different mode.
The unit is not producing warm/cool air.	Verify the following: <ul style="list-style-type: none"> <li>• Temperature setting on remote control is higher/lower than the current temperature.</li> <li>• Air filter is not clogged with dirt.</li> <li>• If the unit has just been turned on, wait 3 minutes for the anti-short cycle timer to expire.</li> <li>• Air flow is unobstructed.</li> <li>• Line size and length is correct and does not exceed factory recommendations.</li> <li>• Operating mode is heat/cool.</li> <li>• If unit is not producing warm air, ensure it is not set to Cool mode.</li> <li>• Remote control is not for a cooling-only unit.</li> <li>• That the unit has not been installed in direct sunlight. If so, hang curtains or shades on windows to filter the sun and increase unit efficiency.</li> </ul>
The fan speed does not change.	Verify that Auto or Dry mode is selected. Either of these modes automatically adjust the fan speed.
Timer function does not work.	Press the Power button on the remote control after setting the time.
Odors permeate the room during operation.	Verify the origin of the odor. Operate the unit in Fan mode or open the windows to air out the room.
The unit makes a bubbling sound.	A bubbling sound may be heard when the refrigerant is circulating through the indoor unit during certain system operating conditions, which should normally be of short duration.
Water is dripping from the air flow blades.	If the unit has been running for an extended period of time with the blades fully open, adjust the blades to mid-position to alleviate condensation formation.
The hand-held remote control is not working.	Verify that: <ul style="list-style-type: none"> <li>• Batteries are not depleted.</li> <li>• Batteries are correctly installed.</li> <li>• Nothing is blocking the remote control sensor.</li> <li>• No strong fluorescent or neon lighting is near the unit, which may interrupt the</li> </ul>
The unit does not turn on/off with the wired remote control.	Ensure that the wired remote control is not set for Group Control.
Indicators on the digital display flash.	Press the Power button on the remote control to turn the unit off. Then switch the circuit break off and then on again.

### Error Codes

As a protection strategy, the unit will stop operating if an error code is generated. If the unit is turned on before the problem is resolved, the error code will re-appear and the unit will stop operating again.

For interpreting error codes, refer to the list of error codes in the Technician Utilities Tool (TUT) or the Service Manual for VRF Outdoor and Indoor Units (VRF-SVM046\*).









Ingersoll Rand (NYSE: IR) advances the quality of life by creating comfortable, sustainable and efficient environments. Our people and our family of brands – including Club Car®, Ingersoll Rand®, Thermo King® and Trane® – work together to enhance the quality and comfort of air in homes and buildings; transport and protect food and perishables; and increase industrial productivity and efficiency. We are a global business committed to a world of sustainable progress and enduring results.



[ingersollrand.com](http://ingersollrand.com)

Ingersoll Rand has a policy of continuous product and product data improvements and reserves the right to change design and specifications without notice.

We are committed to using environmentally conscious print practices.